

## MEDAMEDA

ZTM5661

Termostatico incasso doccia con 3 rubinetti d'arresto. / Built-in therm. shower mixer 3 stop valves.













Termostatico incasso doccia da 1/2", con 3 rubinetti d'arresto. Installazione possibile sia in verticale che in orizzontale.  
1/2" built-in thermostatic shower mixer with 3 stop valves. Both vertical and horizontal installation possible.

R97822

Parte incasso. / Built-in part.



### Finiture / Finishes

 Cromo / Chrome	 C3 Nickel Spazzolato / Brushed Nickel	 C8 Nickel Lucido / Polished Nickel	 C40 Oro / Gold	 C41 Oro spazzolato / Brushed Gold	 C50 Metal Black / Metal Black	 C51 Metal Black spazzolato / Brushed Metal Black
 N1 Nero Opaco Goffrato / Embossed Matt Black	 P31 Brushed PVD British gold / Brushed PVD British gold	 P81 Brushed total black PVD / Brushed total black PVD				

## MEDAMEDA

ZTM5661

Disegno Complessivo / Overall Drawing

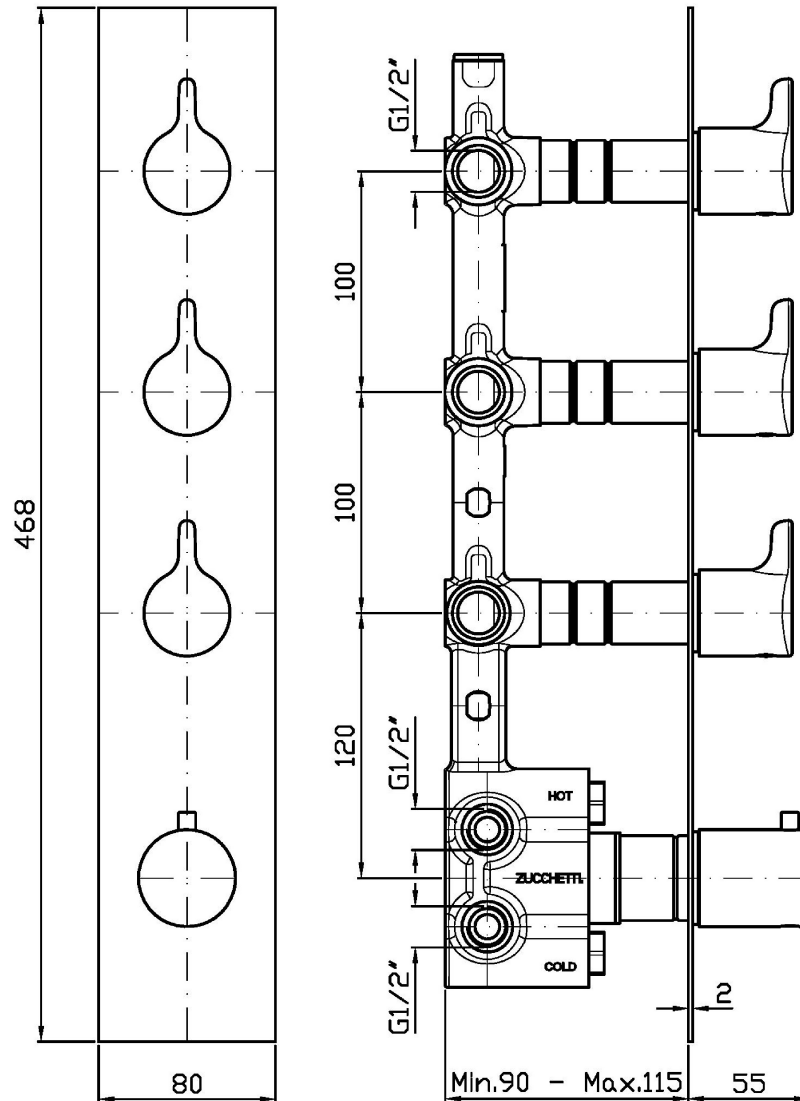

Note / Notes

## MEDAMEDA

### ZTM5661 Portate / Flowrates (lt/min)

PRESSIONE PRESSURE	1 BAR	2 BAR	3 BAR	4 BAR	5 BAR
1 RUBINETTO APERTO <i>P1</i>	13,2	18,4	22,7	26,2	29,2
2 RUBINETTO APERTI 2 TAPS OPENED <i>P2</i>	16,5	23,6	29	33,3	37,6
3 RUBINETTO APERTI 3 TAPS OPENED <i>P3</i>	17,7	25,3	31,3	36,2	40,4
<i>P4</i>					
<i>P5</i>					

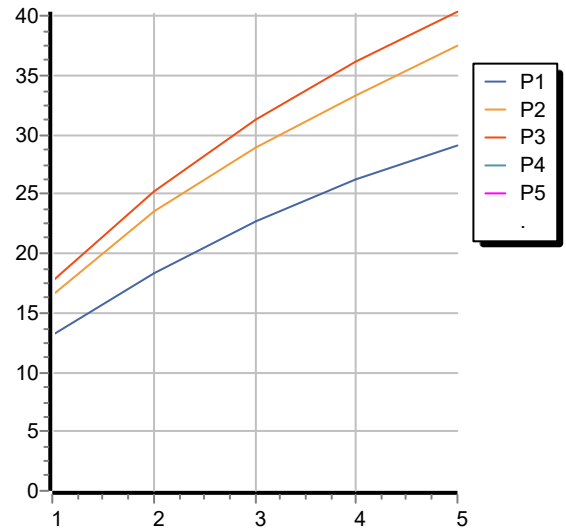

## MEDAMEDA

### ZTM5661 Pesì e Misure / Weights and Sizes

Peso ( Kg ) Weight ( lb )	1,90 ( Kg )	4,19 ( lb )
Volume test ( dc3 ) - ( in3 )	15,98 ( dc3 )	975,16 ( in3 )
h ( mm ) - ( in )	90,00 ( mm )	3,54 ( in )
L1 ( mm ) - ( in )	335,00 ( mm )	13,19 ( in )
L2 ( mm ) - ( in )	530,00 ( mm )	20,87 ( in )

