

MEDAMEDA

ZTM5659

Termostatico incasso doccia con rubinetto d'arresto. / Built-in therm. shower mixer 1 stop valve.



Termostatico incasso doccia da 1/2", con rubinetto d'arresto. Installazione possibile sia in verticale che in orizzontale.











1/2" built-in thermostatic shower mixer with stop valve. Both vertical and horizontal installation possible.

R97820

Parte incasso. / Built-in part.



Finiture / Finishes

| | | | | | | |
|---|---|---|---|---|---|---|
|  |  C3 |  C8 |  C40 |  C41 |  C50 |  C51 |
|  N1 |  P31 |  P81 | | | | |

MEDAMEDA

ZTM5659

Disegno Complessivo / Overall Drawing

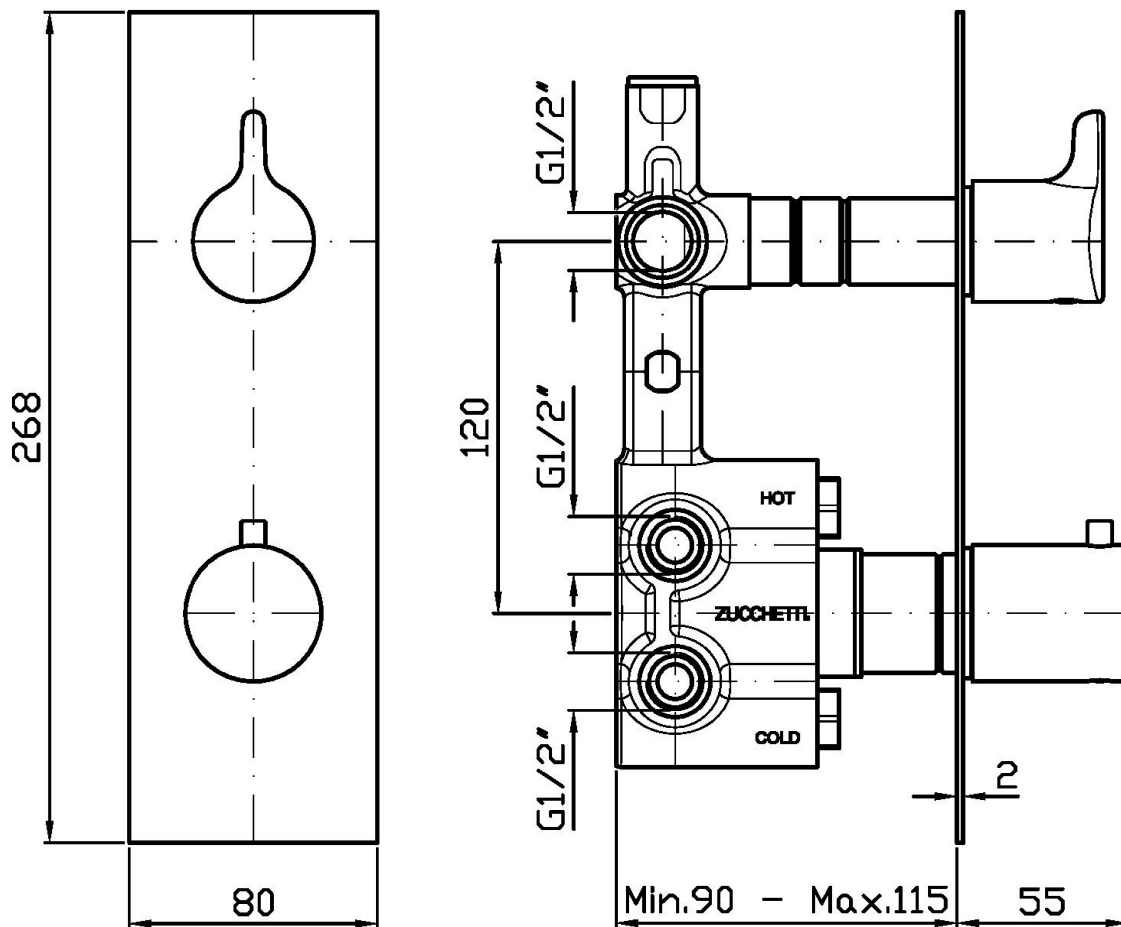

Note / Notes

MEDAMEDA

ZTM5659 Portate / Flowrates (lt/min)

| PRESSIONE PRESSURE | 1 BAR | 2 BAR | 3 BAR | 4 BAR | 5 BAR |
|---------------------------------|-------|-------|-------|-------|-------|
| 1 RUBINETTO APERTO <i>P1</i> | 13,2 | 18,4 | 22,7 | 26,2 | 29,2 |
| <i>P2</i> | | | | | |
| <i>P3</i> | | | | | |
| <i>P4</i> | | | | | |
| <i>P5</i> | | | | | |

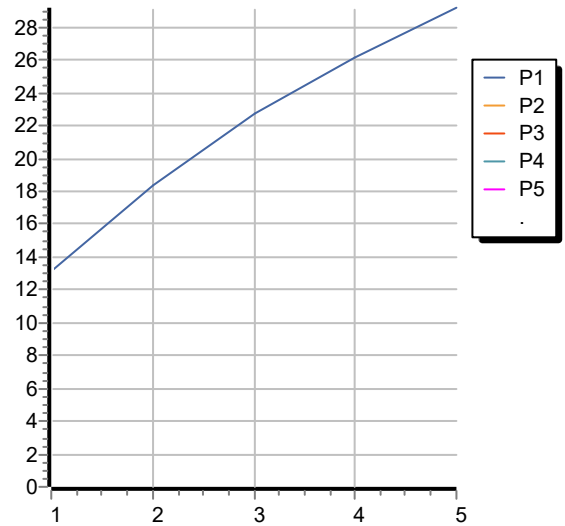

MEDAMEDA

ZTM5659 Pesì e Misure / Weights and Sizes

| | | |
|-------------------------------|---------------|----------------|
| Peso (Kg) Weight (lb) | 1,70 (Kg) | 3,75 (lb) |
| Volume test (dc3) - (in3) | 11,00 (dc3) | 671,26 (in3) |
| h (mm) - (in) | 90,00 (mm) | 3,54 (in) |
| L1 (mm) - (in) | 335,00 (mm) | 13,19 (in) |
| L2 (mm) - (in) | 365,00 (mm) | 14,37 (in) |

