

Marchio / Brand ZUCCHETTI

Classe / Class LAB

## TODD

ZTD666

Termostatico incasso doccia, con 4 rubinetti d'arresto. / Built-in thermostatic shower mixer with 4 stop valves.







Termostatico incasso doccia da 1/2", con 4 rubinetti d'arresto. Installazione possibile sia in verticale che in orizzontale.  
1/2" built-in thermostatic shower mixer with 4 stop valves. Both vertical and horizontal installation possible.

R97823

Parte incasso. / Built-in part.



## Finiture / Finishes

				
Cromo / Chrome	Nickel Spazzolato / Brushed Nickel	Oro spazzolato / Brushed Gold	Metal Black spazzolato / Brushed Metal Black	Nero Opaco Goffrato / Embossed Matt Black

## TODD

ZTD666

Disegno Complessivo / Overall Drawing

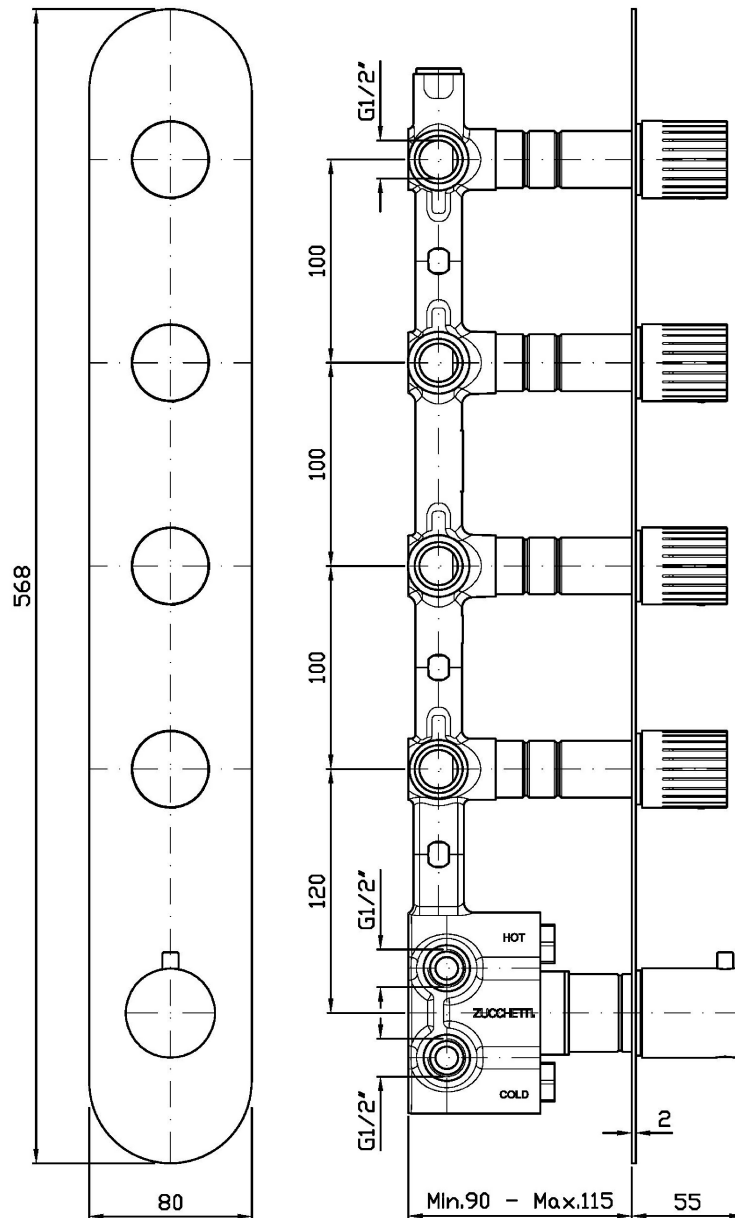

### Note / Notes

## TODD

ZTD666

Portate / Flowrates (lt/min)

PRESSIONE PRESSURE	1 BAR	2 BAR	3 BAR	4 BAR	5 BAR
1 RUBINETTO APERTO <i>P1</i>	13,2	18,4	22,7	26,2	29,2
2 RUBINETTO APERTI 2 TAPS OPENED <i>P2</i>	16,5	23,6	29	33,3	37,6
3 RUBINETTO APERTI 3 TAPS OPENED <i>P3</i>	17,7	25,3	31,3	36,2	40,4
4 RUBINETTO APERTI 4 TAPS OPENED <i>P4</i>	18,5	26	31,9	36,9	41,3
<i>P5</i>					

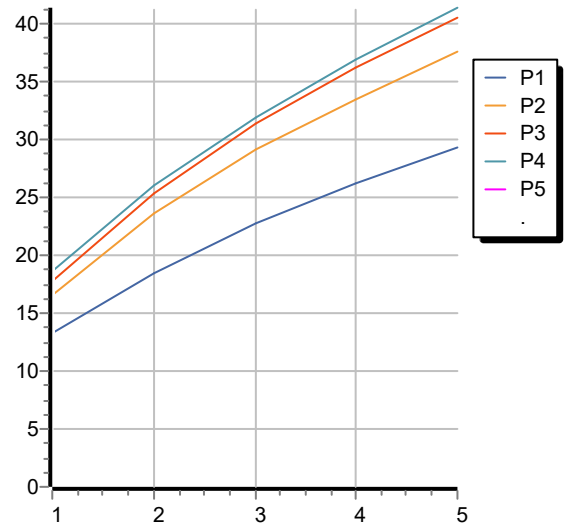

## TODD

ZTD666

Pesi e Misure / Weights and Sizes

Peso ( Kg ) Weight ( lb )	2,60 ( Kg )	5,73 ( lb )
Volume test ( dc3 ) - ( in3 )	15,00 ( dc3 )	915,36 ( in3 )
h ( mm ) - ( in )	140,00 ( mm )	5,51 ( in )
L1 ( mm ) - ( in )	180,00 ( mm )	7,09 ( in )
L2 ( mm ) - ( in )	600,00 ( mm )	23,62 ( in )

