

GILL

ZT2803

Termostatico incasso doccia con 3 rubinetti d'arresto. / Built-in thermostatic shower mixer 3 stop valves.



Termostatico incasso doccia da 3/4", con 3 rubinetti d'arresto. Installazione possibile sia in verticale che in orizzontale.

3/4" built-in thermostatic shower mixer with 3 stop valves. Both vertical and horizontal installation possible.

R96732

Parte incasso / Built-in part



GILL

ZT2803

Finiture / Finishes



Cromo / Chrome



C3

Nickel Spazzolato / Brushed Nickel

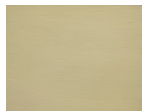

C41

Oro spazzolato / Brushed Gold

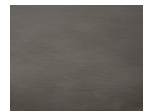

C51

Metal Black spazzolato / Brushed Metal Black

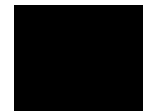

N1

Nero Opaco Goffrato / Embossed Matt Black

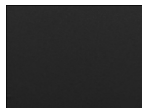

N6

Nero opaco / Matt black

Note / Notes

GILL

ZT2803

Disegno Complessivo / Overall Drawing

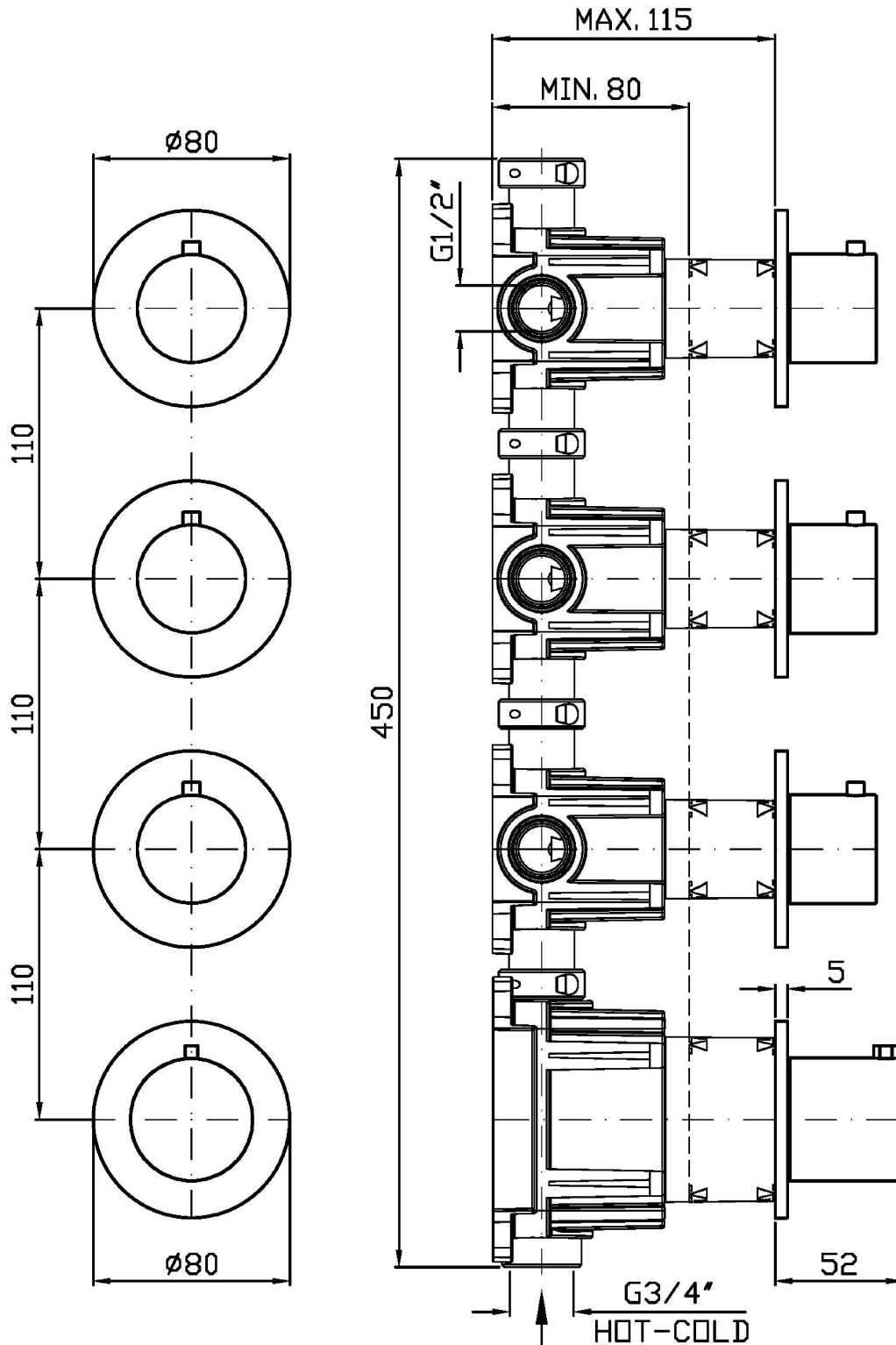

GILL

ZT2803

Esplosi / Exploded

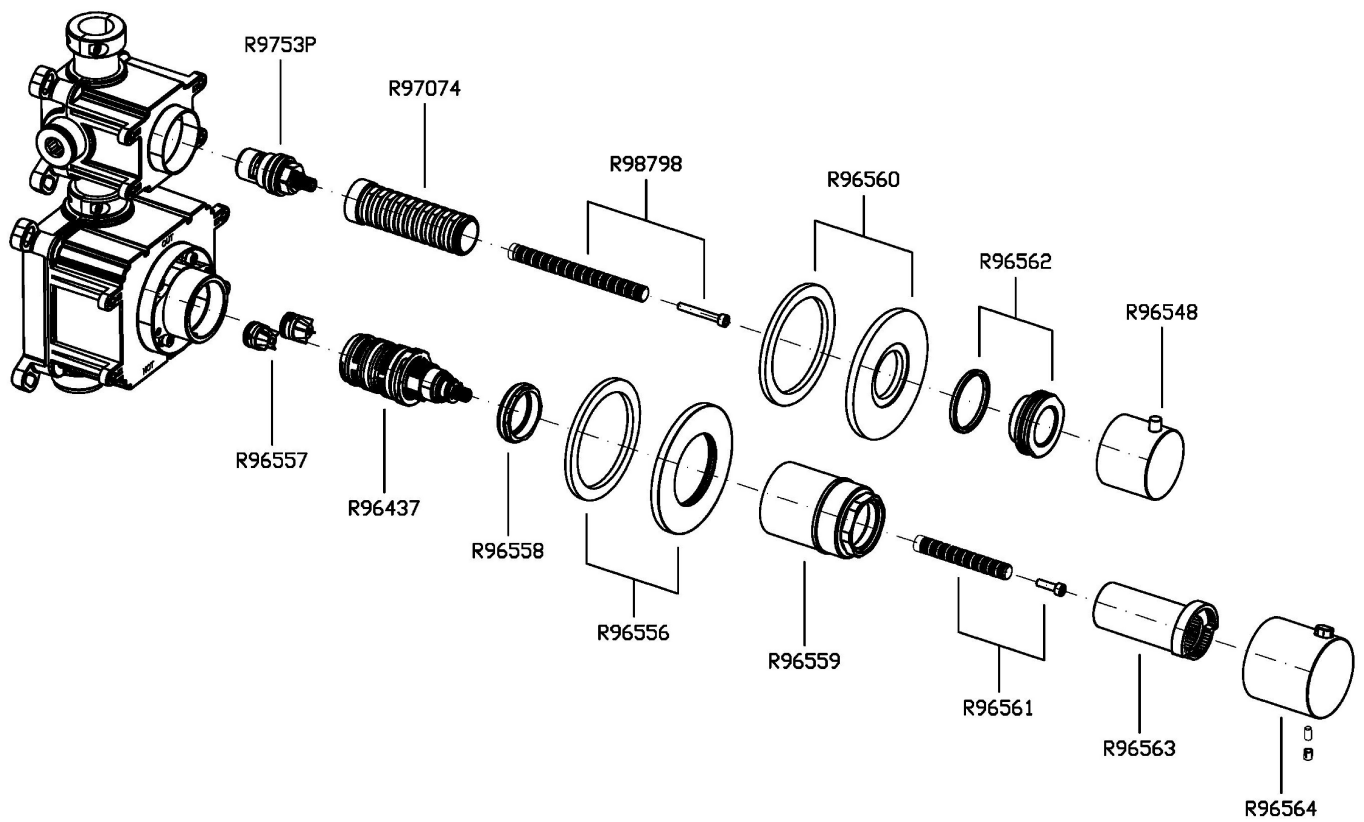

GILL

ZT2803

Portate / Flowrates (lt/min)

PRESSIONE PRESSURE	1 BAR	2 BAR	3 BAR	4 BAR	5 BAR
1 RUBINETTO APERTO <i>P1</i>	13,7	19,1	23,2	26,2	29,5
2 RUBINETTO APERTI 2 TAPS OPENED <i>P2</i>	16,1	22,2	27	30,5	34,2
3 RUBINETTO APERTI 3 TAPS OPENED <i>P3</i>	16,8	23	28	31,6	34,2
<i>P4</i>					
<i>P5</i>					

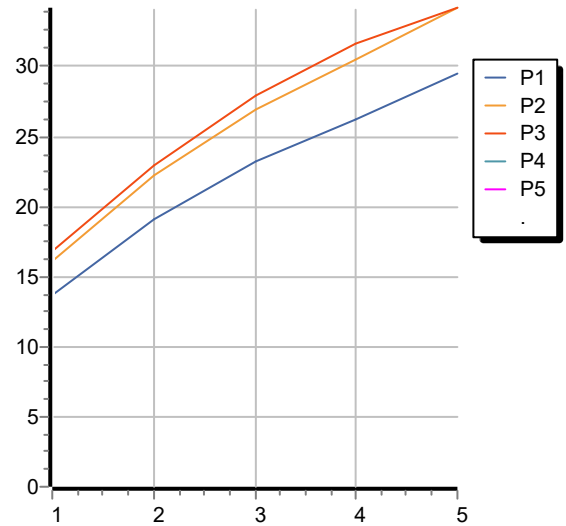

GILL

ZT2803

Pesi e Misure / Weights and Sizes

Peso (Kg) Weight (lb)	2,45 (Kg)	5,40 (lb)
Volume test (dc3) - (in3)	11,01 (dc3)	671,87 (in3)
h (mm) - (in)	90,00 (mm)	3,54 (in)
L1 (mm) - (in)	335,00 (mm)	13,19 (in)
L2 (mm) - (in)	365,00 (mm)	14,37 (in)

