

SABLIER

ZSL5781.X

Batteria lavabo incasso a 3 fori. / 3 hole built-in basin mixer.

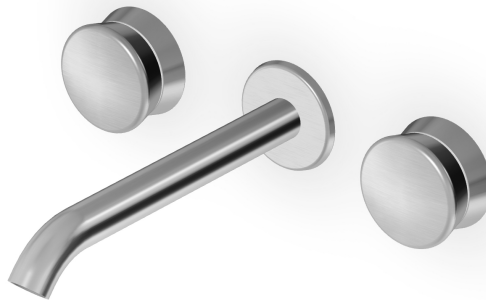

Batteria lavabo incasso a 3 fori in acciaio inox AISI 316L, con aeratore. Lunghezza bocca 195 mm.
Water Saving - portata d'acqua uguale o inferiore a 6 l/min.

3 hole built-in basin mixer in AISI 316L stainless steel, with aerator. Spout L. 195 mm.
Water Saving - water flow rate of 6 l/min or less.

R99500

Parte incasso corpo unico. / Assembled built-in part.















R99504

Parte incasso con elementi liberi, distanza variabile / Built-in part, not assembled, variable distance.



Finiture / Finishes

 X Acciaio inox spazzolato / Brushed stainless steel	 XP21 Brushed PVD chocolate / Brushed PVD chocolate	 XP31 Brushed PVD British gold / Brushed PVD British gold	 XP41 Brushed PVD gold / Brushed PVD gold	 XP81 PVD Brushed Total Black / PVD Brushed Total Black	 XP91 Brushed PVD copper / Brushed PVD copper	 XS Acciaio inox matt / Matt stainless steel
 XSP21 Matt PVD chocolate / Matt PVD chocolate	 XSP31 Matt PVD British gold / Matt PVD British gold	 XSP41 Matt PVD gold / Matt PVD gold	 XSP81 Matt PVD total black / Matt PVD total black	 XSP91 Matt PVD copper / Matt PVD copper		

SABLIER

ZSL5781.X

Disegno Complessivo / Overall Drawing

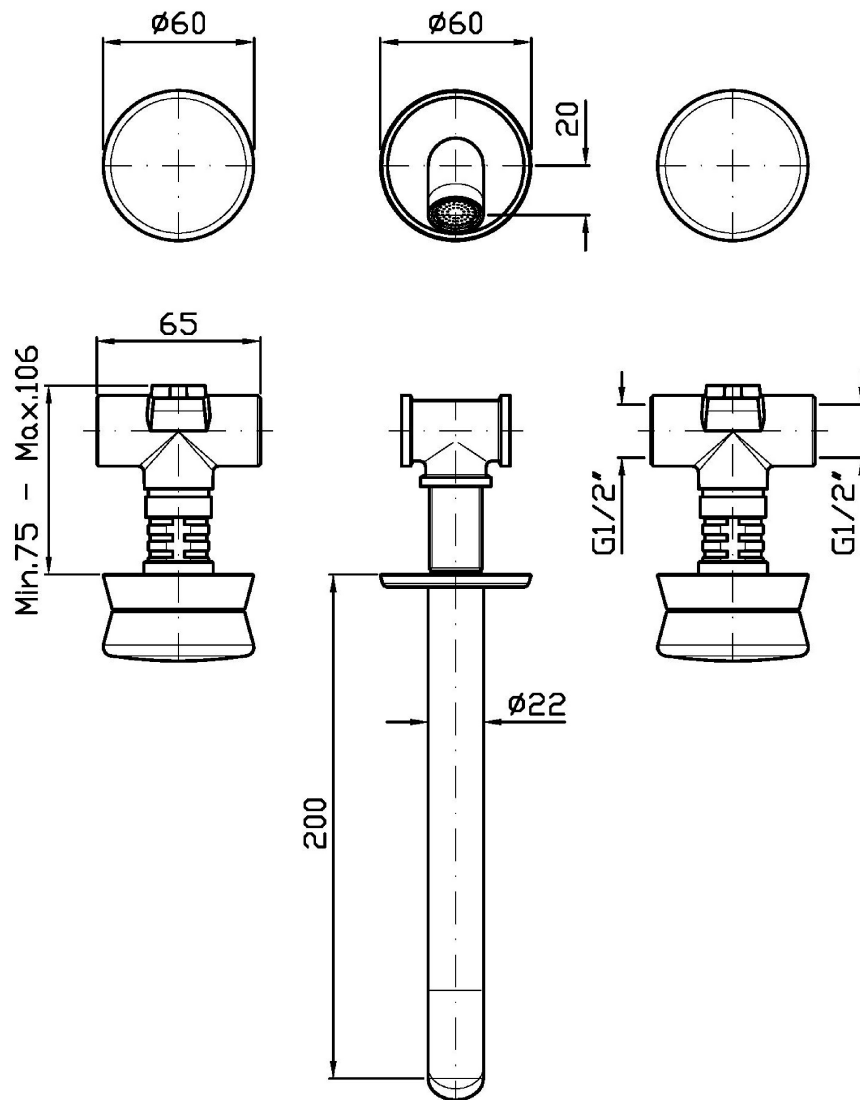

Note / Notes

SABLIER

ZSL5781.X Portate / Flowrates (lt/min)

PRESSIONE PRESSURE	1 BAR	2 BAR	3 BAR	4 BAR	5 BAR
P1 LAVABO BASIN	2,6	3,7	4,4	4,5	4,5
P2					
P3					
P4					
P5					

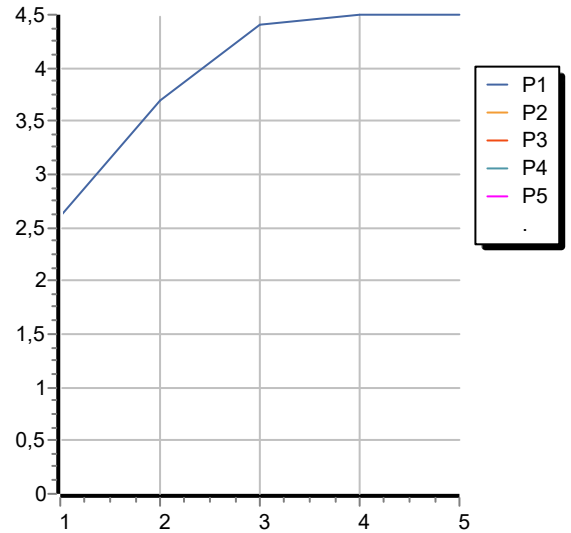

SABLIER

ZSL5781.X Pesì e Misure / Weights and Sizes

Peso (Kg) Weight (lb)	2,60 (Kg)	5,73 (lb)
Volume test (dc3) - (in3)	11,01 (dc3)	671,87 (in3)
h (mm) - (in)	90,00 (mm)	3,54 (in)
L1 (mm) - (in)	335,00 (mm)	13,19 (in)
L2 (mm) - (in)	365,00 (mm)	14,37 (in)

