

## OCTO

ZOC646

Termostatico incasso doccia con deviatore a 2/3 vie. / Built-in thermostatic shower mixer and 2/3 way diverter.



Termostatico incasso doccia da 1/2" e deviatore a 2/3 vie con apertura/chiusura acqua.

1/2" built-in thermostatic shower mixer and 2/3 way diverter with water on/off function.

R97810

Parte incasso termostatico 2 vie / Built-in part -  
2 way thermostatic mixer













R97815

Parte incasso termostatico 3 vie / Built-in part -  
3 way thermostatic mixer



## Finiture / Finishes

 Croma / Chrome	 C3 Nickel Spazzolato / Brushed Nickel	 C8 Nickel Lucido / Polished Nickel	 C50 Metal Black / Metal Black	 C51 Metal Black spazzolato / Brushed Metal Black	 N6 Nero opaco / Matt black	 P21 PVD brushed chocolate / PVD brushed chocolate
 P31 Brushed PVD British gold / Brushed PVD British gold	 P41 PVD Oro Spazzolato / PVD Brushed Gold	 P81 Brushed total black PVD / Brushed total black PVD	 P91 Brushed PVD Copper / Brushed PVD Copper			

## OCTO

ZOC646

Disegno Complessivo / Overall Drawing

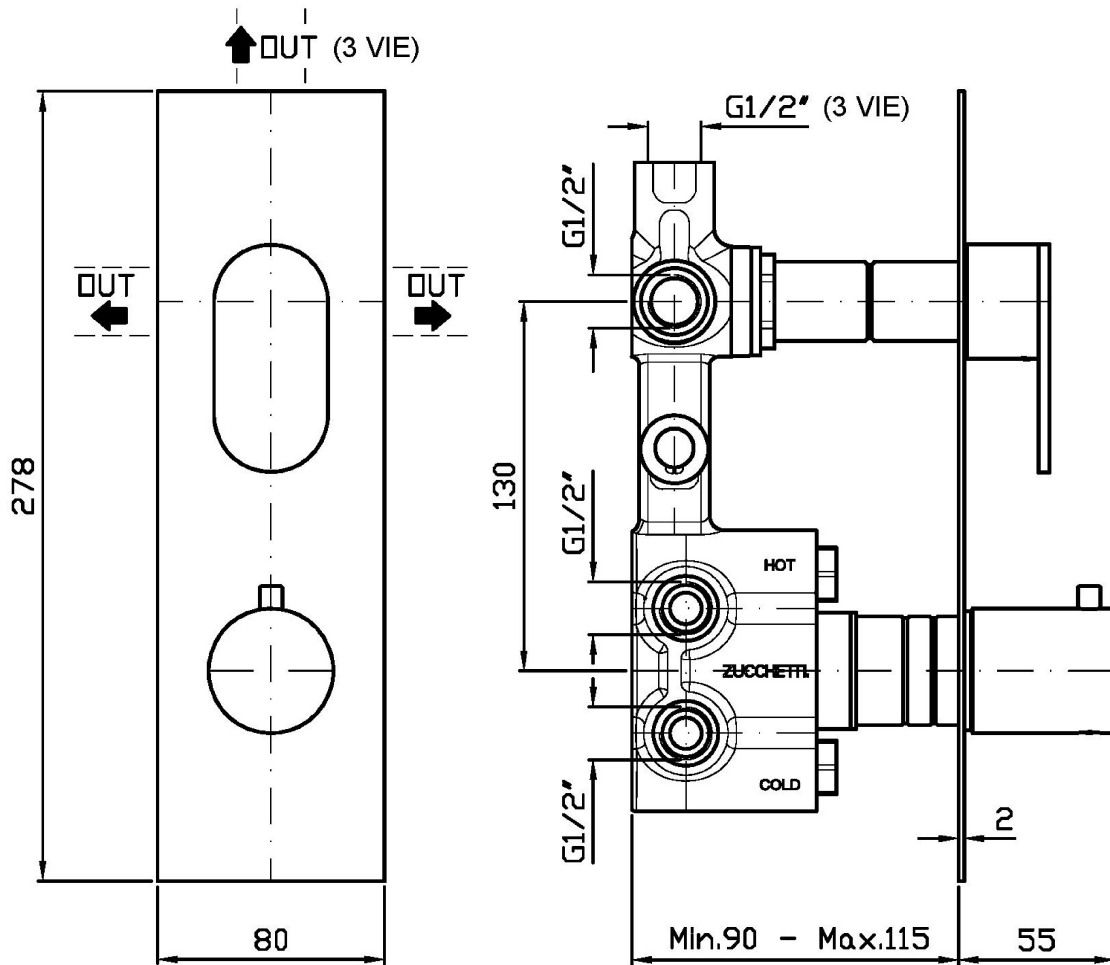

Note / Notes

## OCTO

ZOC646

Esplosi / Exploded

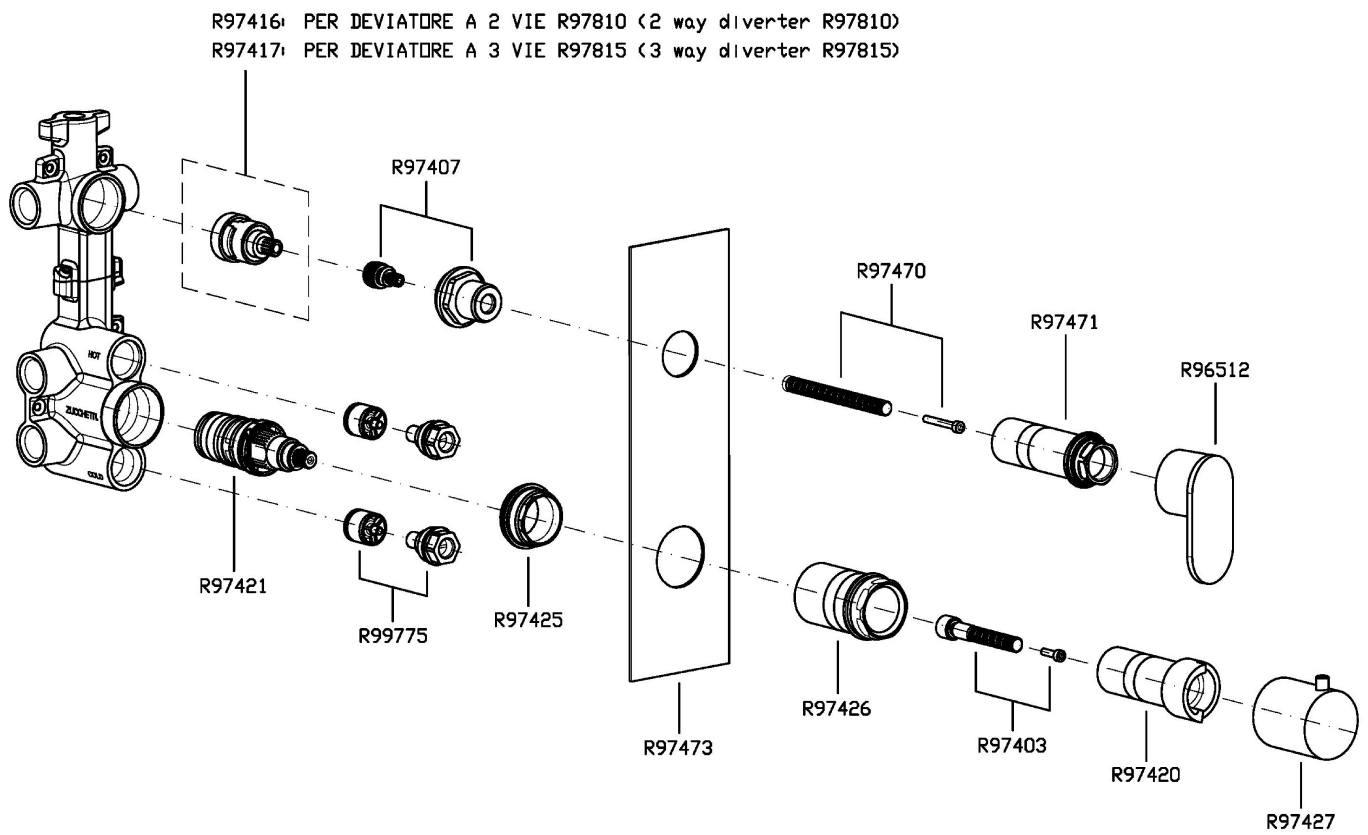

## OCTO

ZOC646

Portate / Flowrates (lt/min)

PRESSIONE PRESSURE	1 BAR	2 BAR	3 BAR	4 BAR	5 BAR
DEVIATORE <i>P1</i>	11,5	16,2	19,5	23,2	26
<i>P2</i>					
<i>P3</i>					
<i>P4</i>					
<i>P5</i>					

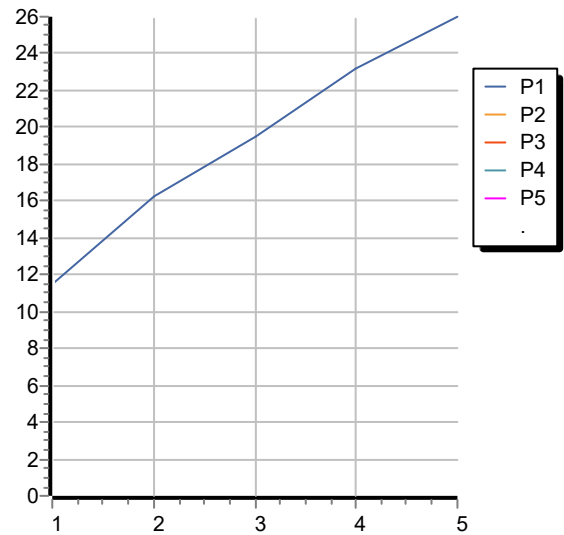

## OCTO

ZOC646

Pesi e Misure / Weights and Sizes

Peso ( Kg ) Weight ( lb )	0,00 ( Kg )	0,00 ( lb )
Volume test ( dc3 ) - ( in3 )	11,01 ( dc3 )	671,87 ( in3 )
h ( mm ) - ( in )	90,00 ( mm )	3,54 ( in )
L1 ( mm ) - ( in )	335,00 ( mm )	13,19 ( in )
L2 ( mm ) - ( in )	365,00 ( mm )	14,37 ( in )

