

MEDAMEDA

ZMM417

Idroscopino wc/bidet completo di miscelatore monocomando incasso. / WC/bidet hydrobrush with built-in mixer.



Idroscopino wc/bidet completo di miscelatore monocomando incasso, doccetta shut-off in ottone, appendidoccia duplex e flessibile da 1200 mm.

Water Saving - portata d'acqua uguale o inferiore a 6 l/min.

WC/bidet hydrobrush with built-in single lever mixer, brass shut-off handshower, handshower support and 1200 mm flexible hose.

Water Saving - water flow rate of 6 l/min or less.

R99499

Parte incasso. / Built-in part.













R99815

Parte incasso. / Built-in part.



Finiture / Finishes

						
Cromo / Chrome	Nickel Spazzolato / Brushed Nickel	Nickel Lucido / Polished Nickel	Oro / Gold	Oro spazzolato / Brushed Gold	Metal Black / Metal Black	Metal Black spazzolato / Brushed Metal Black
						
Nero Opaco Goffrato / Embossed Matt Black	Brushed PVD British gold / Brushed PVD British gold	Brushed total black PVD / Brushed total black PVD				

MEDAMEDA

ZMM417

Disegno Complessivo / Overall Drawing

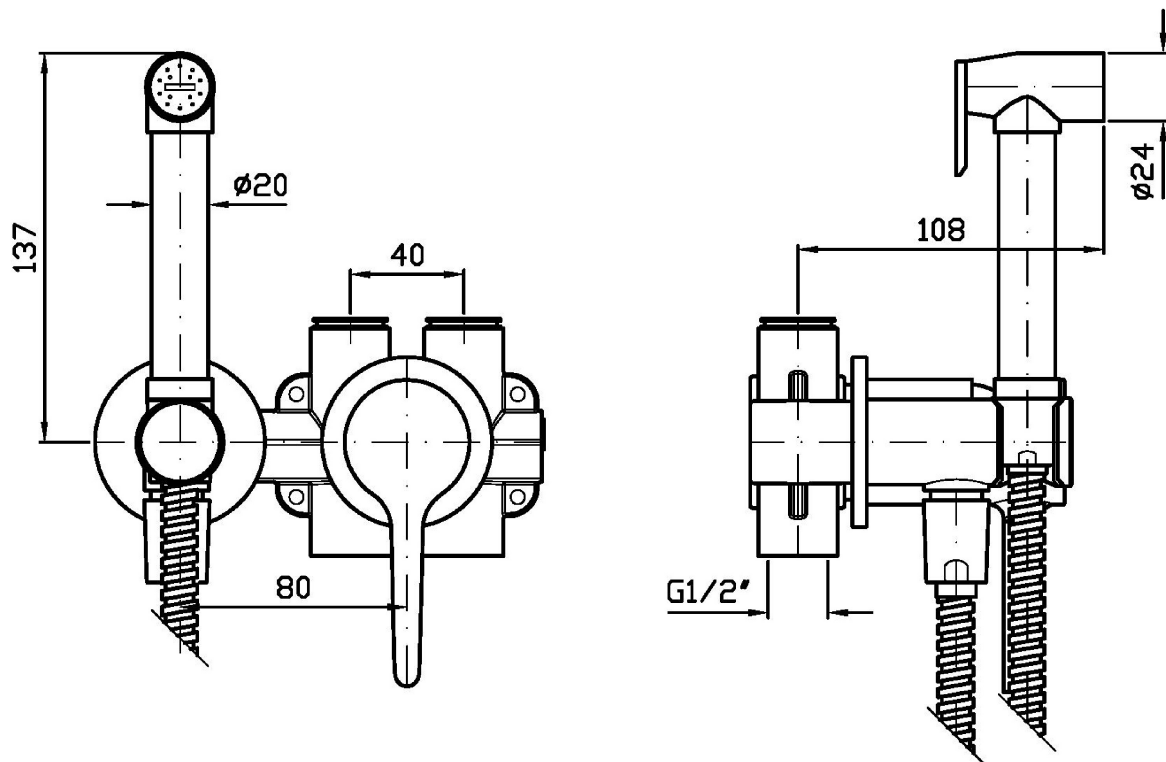

Note / Notes

MEDAMEDA

ZMM417

Esplosi / Exploded

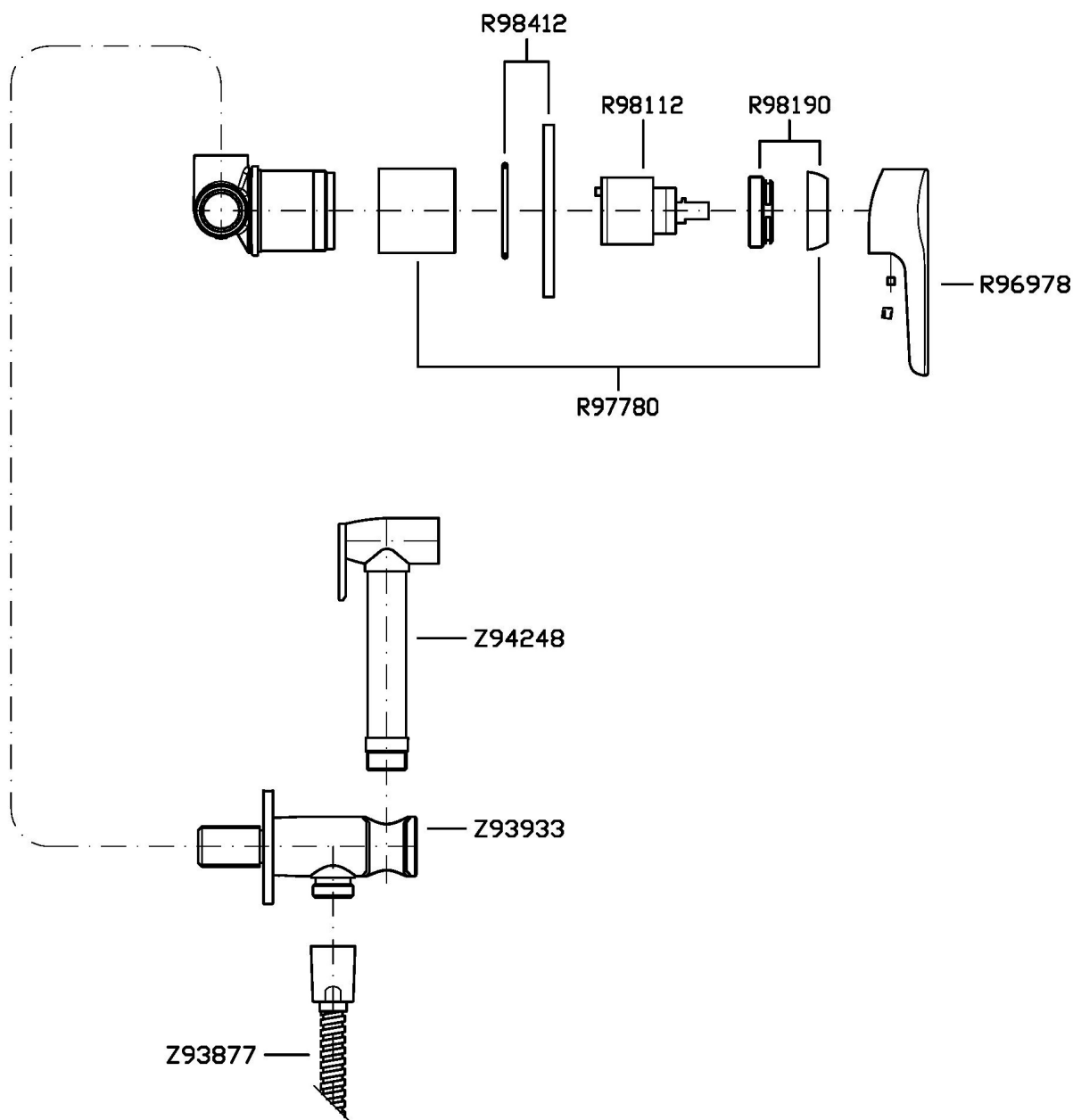

MEDAMEDA

ZMM417 Portate / Flowrates (lt/min)

PRESSIONE PRESSURE	1 BAR	2 BAR	3 BAR	4 BAR	5 BAR
P1 DOCCETTA HANDSHOWER	3,1	4,1	4,7	5	5
P2					
P3					
P4					
P5					

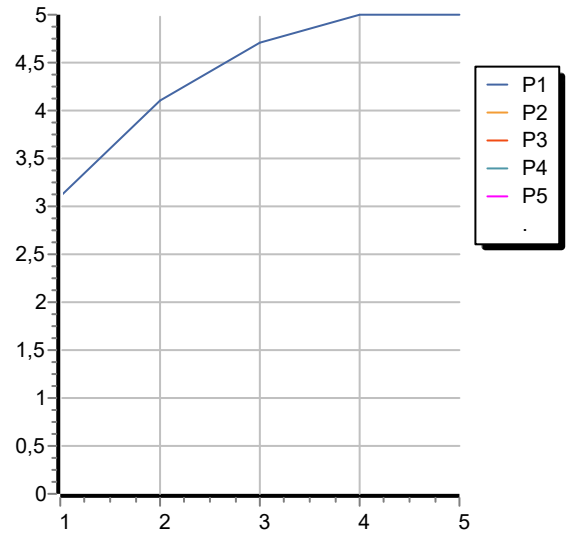

MEDAMEDA

ZMM417 Pesì e Misure / Weights and Sizes

Peso (Kg) Weight (lb)	1,20 (Kg)	2,65 (lb)
Volume test (dc3) - (in3)	4,05 (dc3)	247,15 (in3)
h (mm) - (in)	70,00 (mm)	2,76 (in)
L1 (mm) - (in)	150,00 (mm)	5,91 (in)
L2 (mm) - (in)	385,00 (mm)	15,16 (in)

