

JINGLE

ZIN079

Miscelatore monocomando incasso lavabo. Versione elettronica. / Built-in basin mixer. Electronic version.



Miscelatore monocomando incasso lavabo con aeratore. Versione elettronica.
Water Saving - portata d'acqua uguale o inferiore a 6 l/min.









Built-in basin mixer with aerator. Electronic version.
Water Saving - water flow rate of 6 l/min or less.

R99688

Parte incasso. / Built-in part.



Finiture / Finishes

 Cromo / Chrome	 C3 Nickel Spazzolato / Brushed Nickel	 C8 Nickel Lucido / Polished Nickel	 C40 Oro / Gold	 C41 Oro spazzolato / Brushed Gold	 C50 Metal Black / Metal Black	 C51 Metal Black spazzolato / Brushed Metal Black	 W1 Bianco Opaco Goffrato / Embossed Matt White
 N1 Nero Opaco Goffrato / Embossed Matt Black							

JINGLE

ZIN079

Disegno Complessivo / Overall Drawing

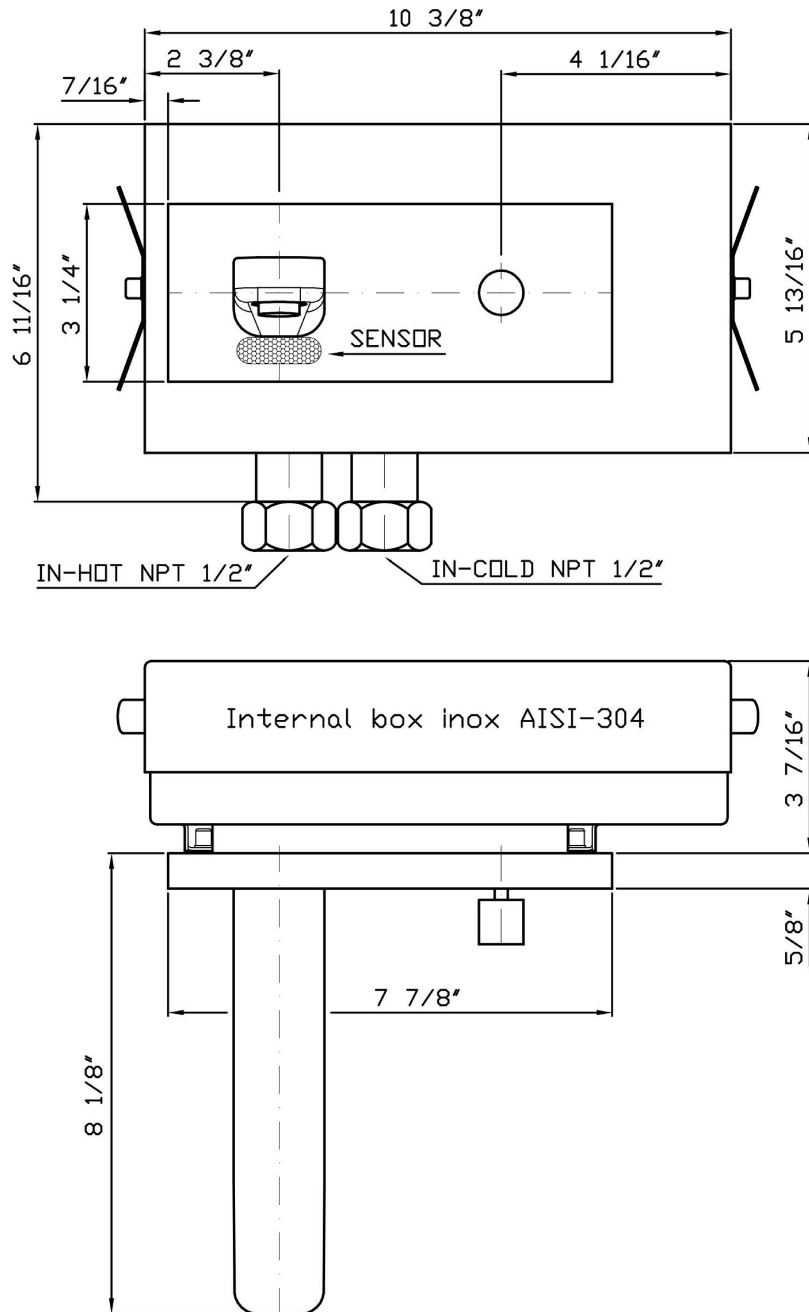

JINGLE

ZIN079

Esplosi / Exploded

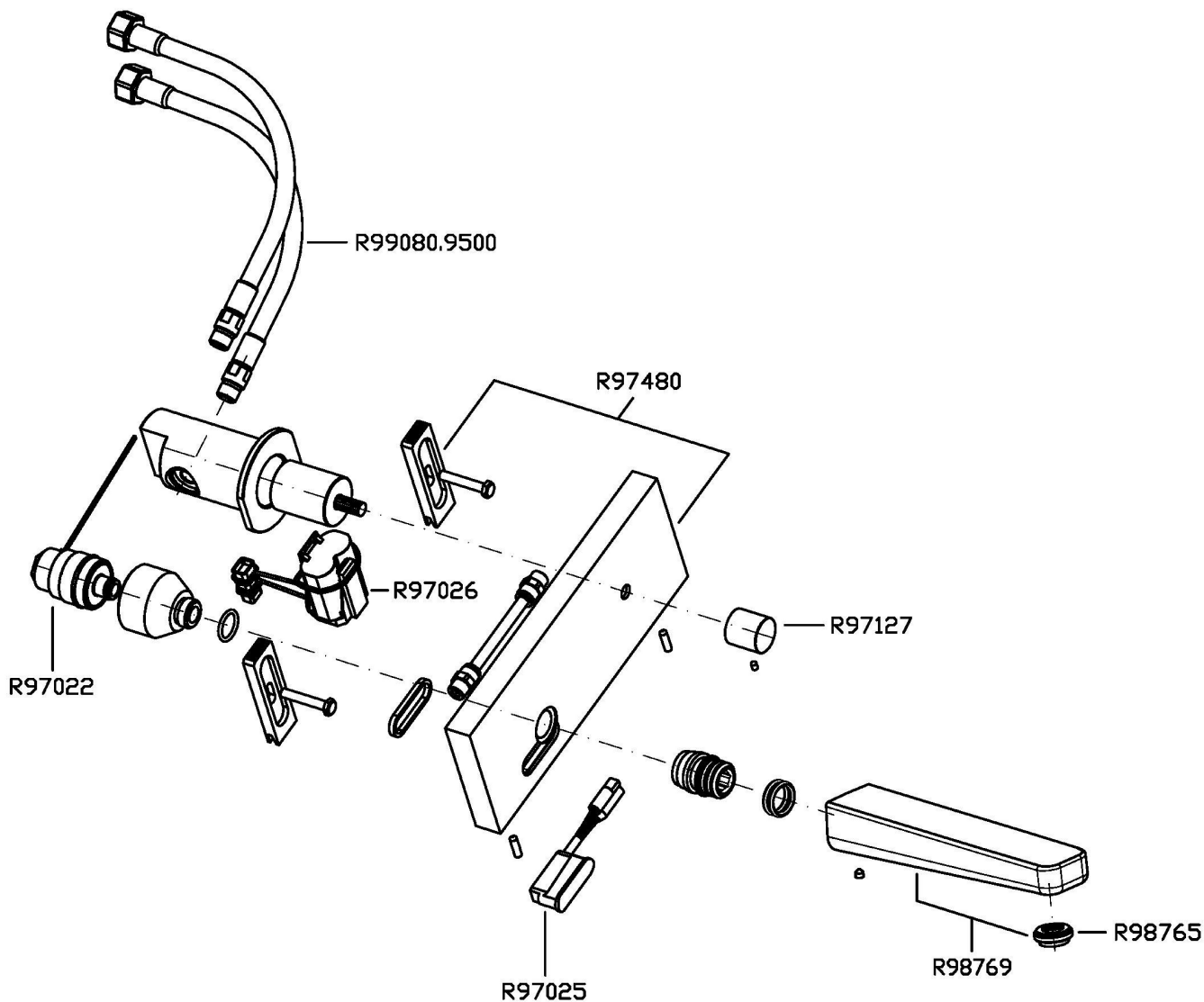

JINGLE

ZIN079

Portate / Flowrates (lt/min)

PRESSIONE PRESSURE	1 BAR	2 BAR	3 BAR	4 BAR	5 BAR
P1 LAVABO BASIN	2,7	3,9	4,7	5,4	5,9
P2					
P3					
P4					
P5					

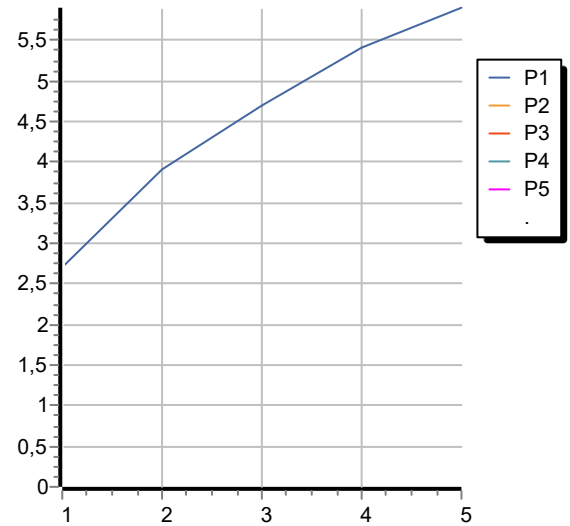

JINGLE

ZIN079

Pesi e Misure / Weights and Sizes

Peso (Kg) Weight (lb)	3,20 (Kg)	7,05 (lb)
Volume test (dc3) - (in3)	7,43 (dc3)	453,41 (in3)
h (mm) - (in)	90,00 (mm)	3,54 (in)
L1 (mm) - (in)	250,00 (mm)	9,84 (in)
L2 (mm) - (in)	333,00 (mm)	13,11 (in)

