

HOOP

ZHO782

Termostatico incasso doccia a 2 pulsanti. / Built-in thermostatic shower mixer, with 2 on-off buttons.

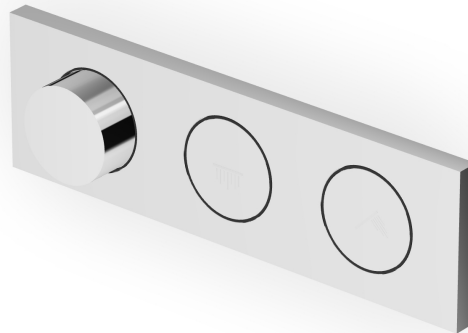

Termostatico incasso doccia da 1/2", combinazione con 2 pulsanti on-off per soffione e doccia. Installazione possibile sia in verticale che in orizzontale.











1/2" built-in thermostatic shower mixer, arrangement with 2 on-off buttons for shower head and handshower. Both vertical and horizontal installation possible.

R96702

Parte incasso / Built-in part



Finiture / Finishes

						
<p>Cromo / Chrome</p>	<p>Nickel Spazzolato / Brushed Nickel</p>	<p>Nickel Lucido / Polished Nickel</p>	<p>Oro / Gold</p>	<p>Oro spazzolato / Brushed Gold</p>	<p>Metal Black / Metal Black</p>	<p>Metal Black spazzolato / Brushed Metal Black</p>
						
<p>Bianco Opaco Goffrato / Embossed Matt White</p>	<p>Nero Opaco Goffrato / Embossed Matt Black</p>	<p>Nero opaco / Matt black</p>	<p>Blu mediterraneo / Mediterranean blu</p>	<p>PVD brushed chocolate / PVD brushed chocolate</p>	<p>Brushed PVD British gold / Brushed PVD British gold</p>	<p>PVD Oro Spazzolato / PVD Brushed Gold</p>
						
<p>Brushed total black PVD / Brushed total black PVD</p>	<p>Brushed PVD Copper / Brushed PVD Copper</p>					

HOOP

ZHO782

Disegno Complessivo / Overall Drawing

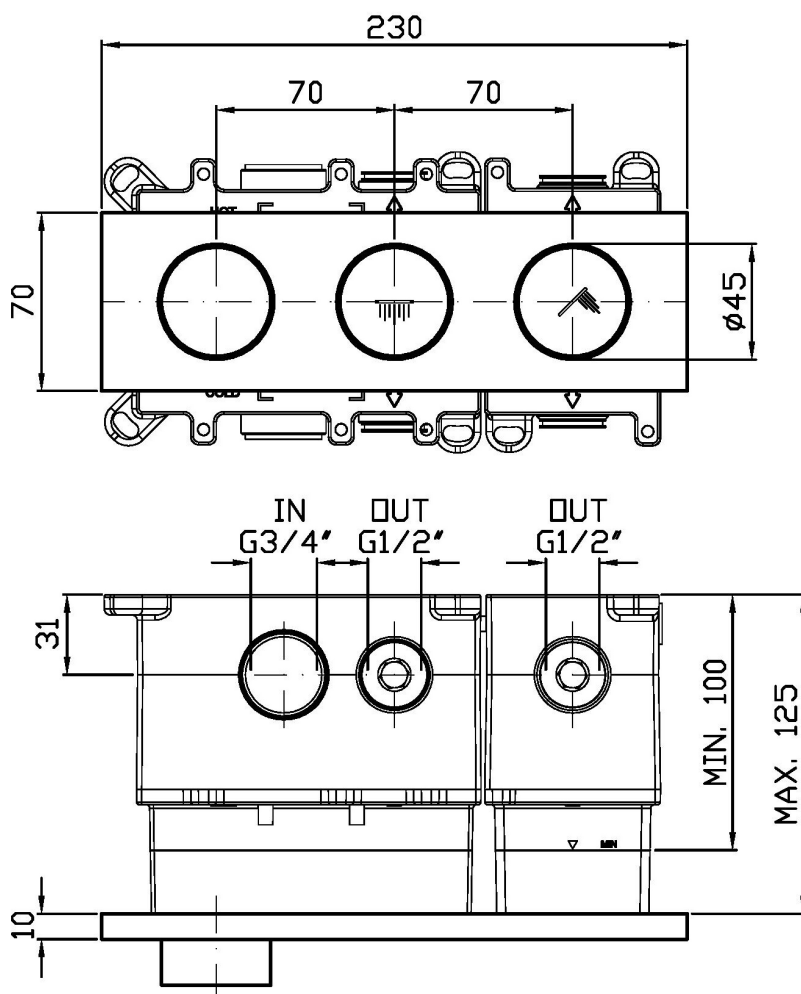

Note / Notes

Articolo non compatibile con bocca Z93768 e soffioni Z94218, Z94229 e Z94230.

Item not compatible with spout code Z93768 and shower heads codes Z94218, Z94229, Z94230.

HOOP

ZHO782

Portate / Flowrates (lt/min)

PRESSIONE PRESSURE	1 BAR	2 BAR	3 BAR	4 BAR	5 BAR
1 RUBINETTO APERTO <i>P1</i>	7	11	13,5	15	16,5
2 RUBINETTI APERTI 2 TAPS OPENED <i>P2</i>	10,5	16	20	23	26
<i>P3</i>					
<i>P4</i>					
<i>P5</i>					

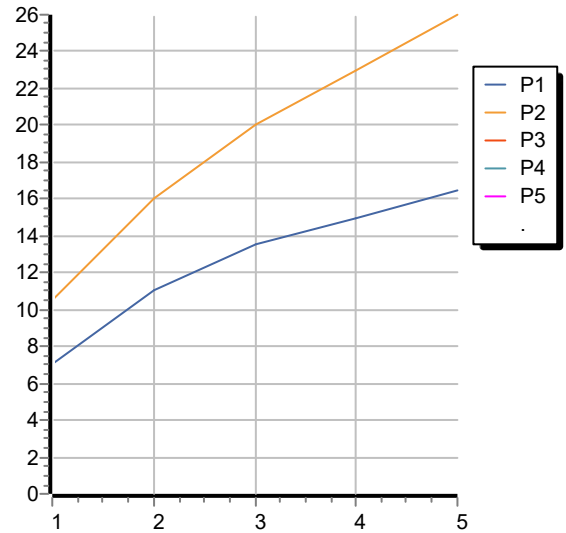

HOOP

ZHO782

Pesi e Misure / Weights and Sizes

Peso (Kg) Weight (lb)	1,70 (Kg)	3,75 (lb)
Volume test (dc3) - (in3)	7,80 (dc3)	475,98 (in3)
h (mm) - (in)	90,00 (mm)	3,54 (in)
L1 (mm) - (in)	250,00 (mm)	9,84 (in)
L2 (mm) - (in)	333,00 (mm)	13,11 (in)

