

## HELM

ZHM803.X

Termostatico incasso doccia con 3 rubinetti d'arresto. / Built-in thermostatic shower mixer with 3 stop valves.

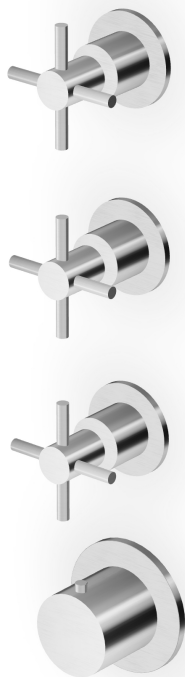

Termostatico incasso doccia da 3/4", in acciaio inox AISI 316L, con 3 rubinetti d'arresto. Installazione possibile sia in verticale che in orizzontale.

3/4" built-in thermostatic shower mixer in AISI 316L stainless steel, with 3 stop valves. Both vertical and horizontal installation possible.

R96732

Parte incasso / Built-in part



## HELM

ZHM803.X

Finiture / Finishes



**X**

Acciaio inox spazzolato /  
Brushed stainless steel



**XG2**

Acciaio inox spazz.-godr.  
verticale / Br. stainless  
steel-Vertical knurling



**XG3**

Acciaio inox  
spazz.-godronatura diagonale  
/ Br. stainless steel-diagonal



**XP21**

Brushed PVD chocolate /  
Brushed PVD chocolate

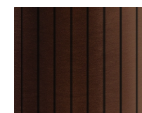

**XP21G**

Brushed PVD chocolate  
godronatura verticale / Br.  
PVD chocolate-vertical

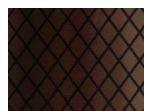

**XP21G**

Brushed PVD  
chocolate-godronatura  
diagonale / Br. PVD



**XP31**

Brushed PVD British gold /  
Brushed PVD British gold



**XP31G**

Br. PVD British gold-godr.  
verticale / Br. PVD British  
gold-vertical knurling



**XP31G**

Br. PVD British gold-godr.  
diagonale / Br. PVD British  
gold-diagonal knurling



**XP41**

Brushed PVD gold / Brushed  
PVD gold



**XP41G**

Br. PVD gold-godronatura  
verticale / Brushed PVD  
gold-vertical knurling



**XP41G**

Br. PVD gold-godr. diagonale /  
Br. PVD gold-diagonal knurling



**XP81**

PVD Brushed Total Black /  
PVD Brushed Total Black



**XP81G**

Br. PVD Total Black-godr.  
verticale / Br. PVD Total  
Black-vertical knurling



**XP81G**

Br. PVD Total Black-godr.  
diagonale / Br. PVD Total  
Black-diagonal knurling



**XP91**

Brushed PVD copper /  
Brushed PVD copper

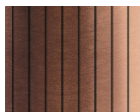

**XP91G**

Br. PVD copper-godr.  
verticale / Br. PVD  
copper-vertical knurling

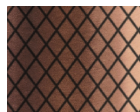

**XP91G**

Br. PVD copper-godr.  
diagonale / Br. PVD  
copper-diagonal knurling

Note / Notes

## HELM

ZHM803.X

Disegno Complessivo / Overall Drawing

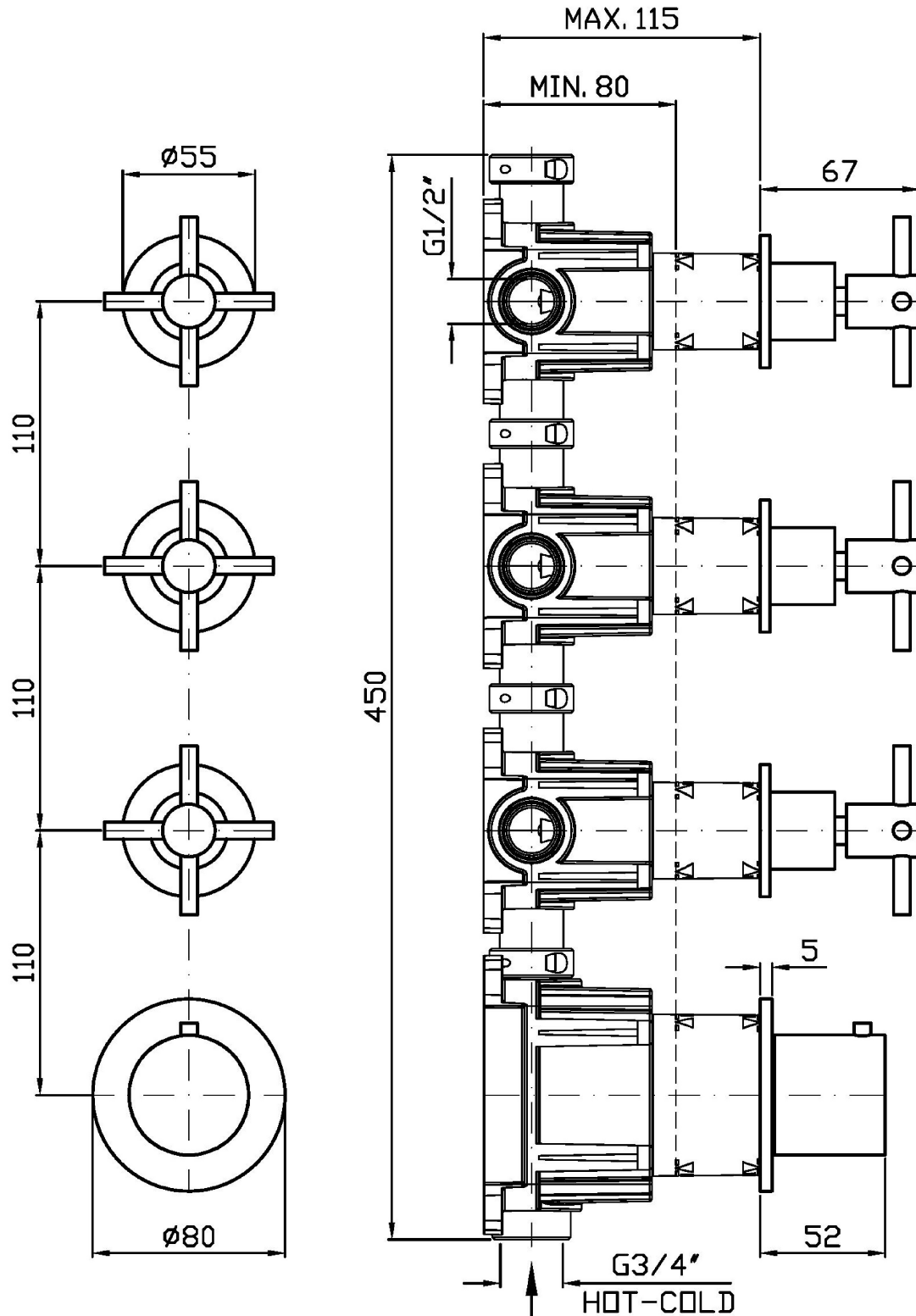

## HELM

ZHM803.X

Esplosi / Exploded

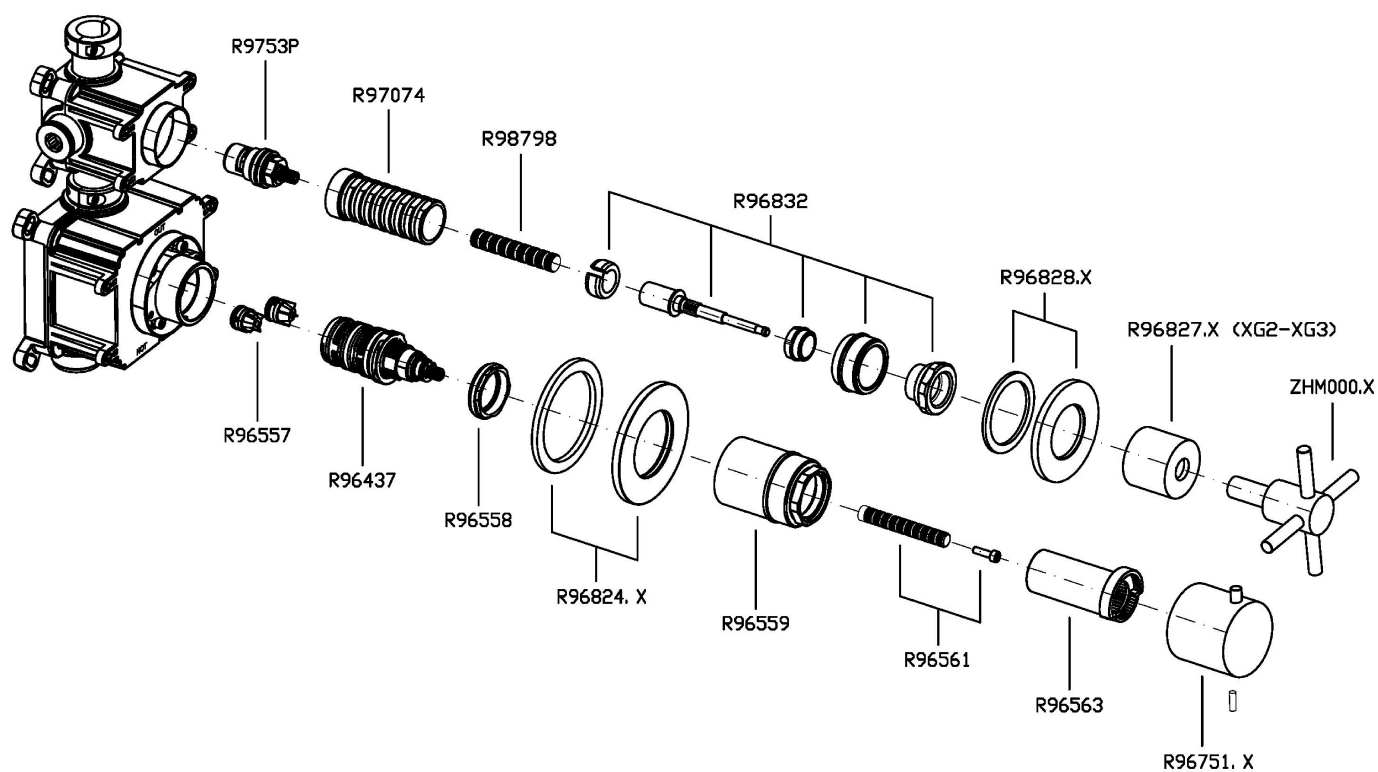

## HELM

### ZHM803.X Portate / Flowrates (lt/min)

| PRESSIONE<br>PRESSURE                            | 1 BAR | 2 BAR | 3 BAR | 4 BAR | 5 BAR |
|--|-------|-------|-------|-------|-------|
| 1 RUBINETTO APERTO<br><i>P1</i>                  | 13,7  | 19,1  | 23,2  | 26,2  | 29,5  |
| 2 RUBINETTO APERTI<br>2 TAPS OPENED<br><i>P2</i> | 16,1  | 22,2  | 27    | 30,5  | 34,2  |
| 3 RUBINETTO APERTI<br>3 TAPS OPENED<br><i>P3</i> | 16,8  | 23    | 28    | 31,6  | 34,2  |
| <i>P4</i>  |       |       |       |       |       |
| <i>P5</i>  |       |       |       |       |       |

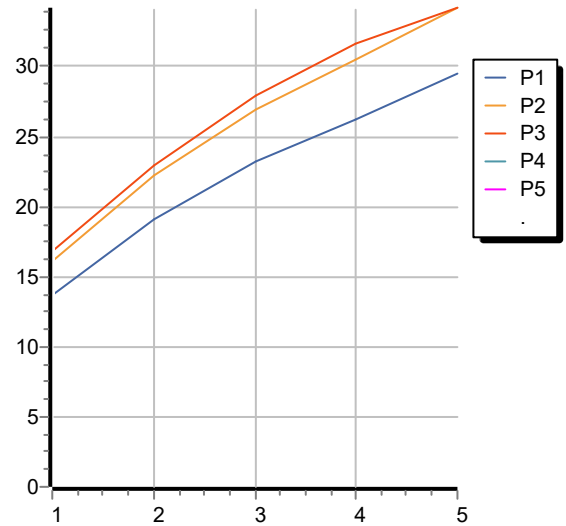

## HELM

### ZHM803.X Pesi e Misure / Weights and Sizes

|                               |               |                |
|-------------------------------|---------------|----------------|
| Peso ( Kg ) Weight ( lb )     | 2,50 ( Kg )   | 5,51 ( lb )    |
| Volume test ( dc3 ) - ( in3 ) | 11,01 ( dc3 ) | 671,87 ( in3 ) |
| h ( mm ) - ( in )             | 90,00 ( mm )  | 3,54 ( in )    |
| L1 ( mm ) - ( in )            | 335,00 ( mm ) | 13,19 ( in )   |
| L2 ( mm ) - ( in )            | 365,00 ( mm ) | 14,37 ( in )   |

