

## HELM

ZHL802.X

Termostatico incasso doccia con 2 rubinetti d'arresto. / Built-in thermostatic shower mixer with 2 stop valves.



Termostatico incasso doccia da 3/4", in acciaio inox AISI 316L, con 2 rubinetti d'arresto. Installazione possibile sia in verticale che in orizzontale.

3/4" built-in thermostatic shower mixer in AISI 316L stainless steel, with 2 stop valves. Both vertical and horizontal installation possible.

R96731

Parte incasso / Built-in part



## HELM

ZHL802.X

Finiture / Finishes



**X**

Acciaio inox spazzolato /  
Brushed stainless steel

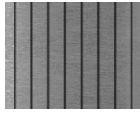

**XG2**

Acciaio inox spazz.-godr.  
verticale / Br. stainless  
steel-Vertical knurling



**XG3**

Acciaio inox  
spazz.-godronatura diagonale  
/ Br. stainless steel-diagonal

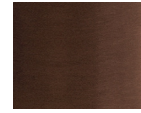

**XP21**

Brushed PVD chocolate /  
Brushed PVD chocolate

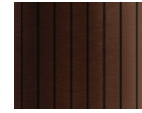

**XP21G**

Brushed PVD chocolate  
godronatura verticale / Br.  
PVD chocolate-vertical



**XP21G**

Brushed PVD  
chocolate-godronatura  
diagonale / Br. PVD



**XP31**

Brushed PVD British gold /  
Brushed PVD British gold



**XP31G**

Br. PVD British gold-godr.  
verticale / Br. PVD British  
gold-vertical knurling

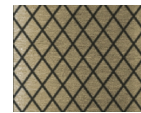

**XP31G**

Br. PVD British gold-godr.  
diagonale / Br. PVD British  
gold-diagonal knurling



**XP41**

Brushed PVD gold / Brushed  
PVD gold



**XP41G**

Br. PVD gold-godronatura  
verticale / Brushed PVD  
gold-vertical knurling

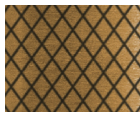

**XP41G**

Br. PVD gold-godr. diagonale /  
Br. PVD gold-diagonal knurling



**XP81**

PVD Brushed Total Black /  
PVD Brushed Total Black



**XP81G**

Br. PVD Total Black-godr.  
verticale / Br. PVD Total  
Black-vertical knurling

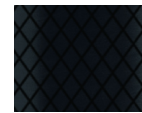

**XP81G**

Br. PVD Total Black-godr.  
diagonale / Br. PVD Total  
Black-diagonal knurling



**XP91**

Brushed PVD copper /  
Brushed PVD copper

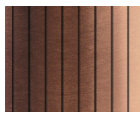

**XP91G**

Br. PVD copper-godr.  
verticale / Br. PVD  
copper-vertical knurling



**XP91G**

Br. PVD copper-godr.  
diagonale / Br. PVD  
copper-diagonal knurling

Note / Notes

## HELM

ZHL802.X

Disegno Complessivo / Overall Drawing

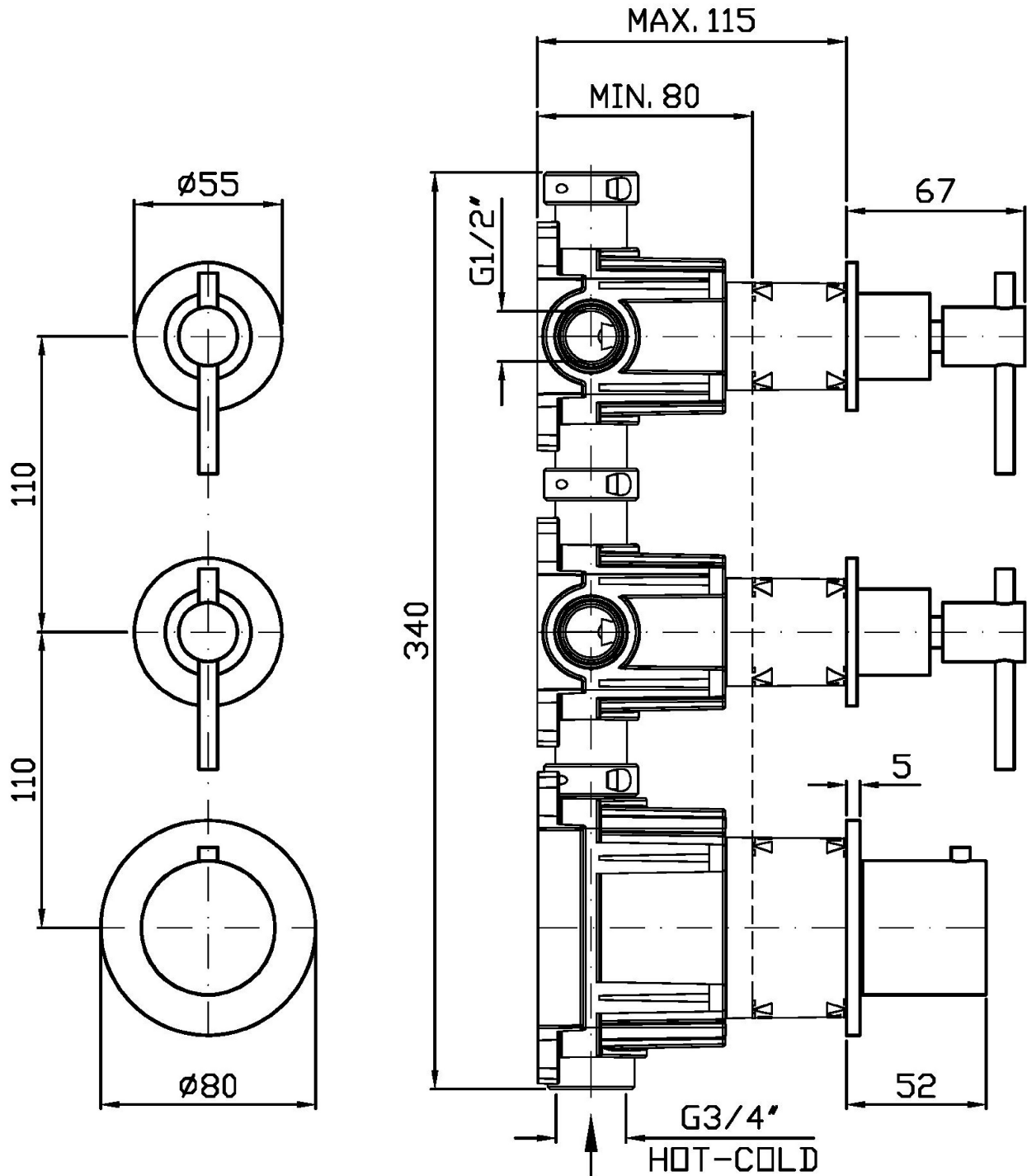

## HELM

ZHL802.X

Esplosi / Exploded

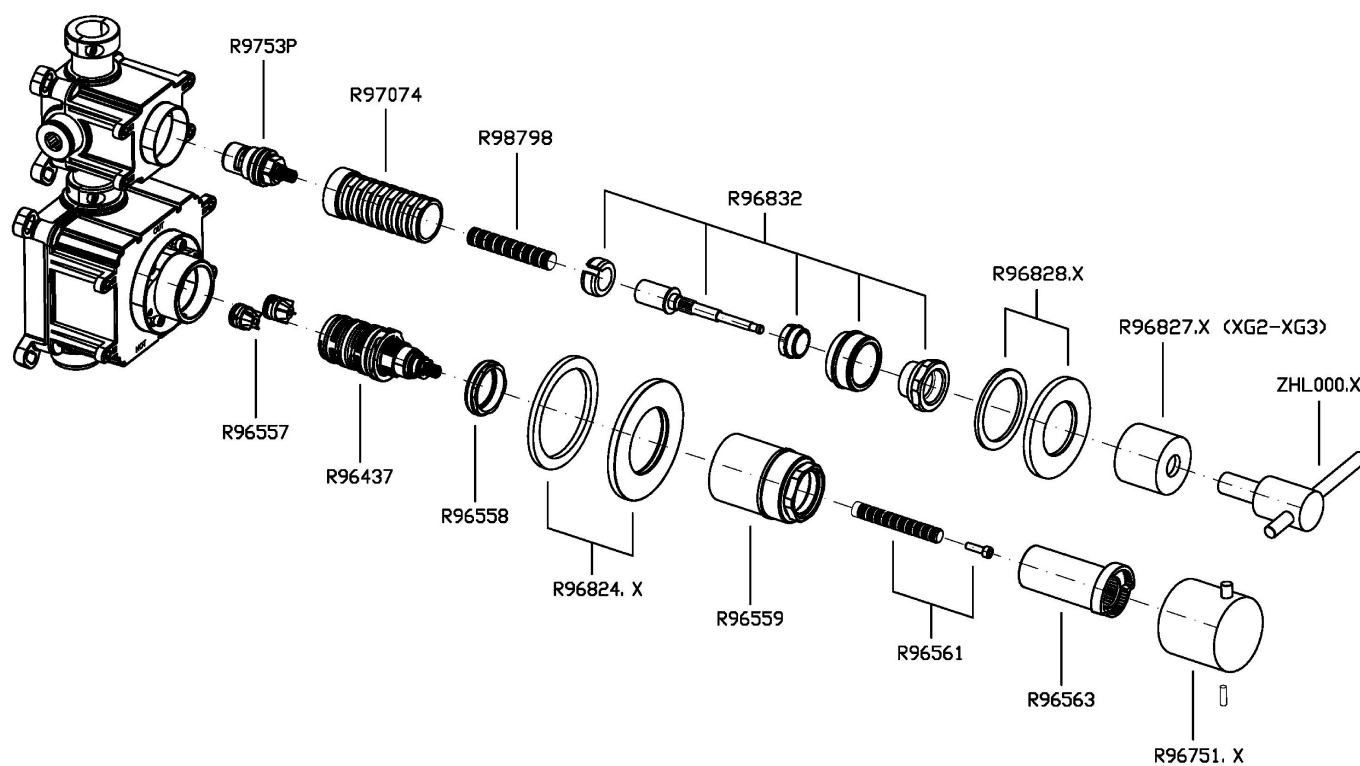

## HELM

ZHL802.X

Portate / Flowrates (lt/min)

PRESSIONE PRESSURE	1 BAR	2 BAR	3 BAR	4 BAR	5 BAR
1 RUBINETTO APERTO <i>P1</i>	13,7	19,1	23,2	26,2	29,5
2 RUBINETTI APERTI 2 TAPS OPENED <i>P2</i>	16,1	22,2	27	30,5	34,2
<i>P3</i>					
<i>P4</i>					
<i>P5</i>					

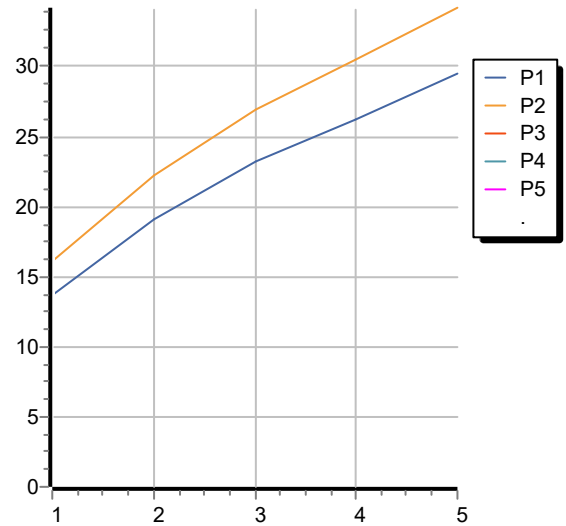

## HELM

ZHL802.X

Pesi e Misure / Weights and Sizes

Peso ( Kg ) Weight ( lb )	2,10 ( Kg )	4,63 ( lb )
Volume test ( dc3 ) - ( in3 )	7,50 ( dc3 )	457,68 ( in3 )
h ( mm ) - ( in )	90,00 ( mm )	3,54 ( in )
L1 ( mm ) - ( in )	335,00 ( mm )	13,19 ( in )
L2 ( mm ) - ( in )	365,00 ( mm )	14,37 ( in )

