

HELM

ZHL801.X

Termostatico incasso doccia con un rubinetto d'arresto. / Built-in thermostatic shower mixer with stop valve.



Termostatico incasso doccia da 3/4", in acciaio inox AISI 316L, con un rubinetto d'arresto. Installazione possibile sia in verticale che in orizzontale.

3/4" built-in thermostatic shower mixer in AISI 316L stainless steel, with stop valve. Both vertical and horizontal installation possible.

R96730

Parte incasso / Built-in part



HELM

ZHL801.X

Finiture / Finishes



X

Acciaio inox spazzolato /
Brushed stainless steel



XG2

Acciaio inox spazz.-godr.
verticale / Br. stainless
steel-Vertical knurling



XG3

Acciaio inox
spazz.-godronatura diagonale
/ Br. stainless steel-diagonal



XP21

Brushed PVD chocolate /
Brushed PVD chocolate

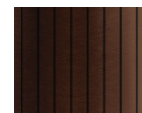

XP21G

Brushed PVD chocolate
godronatura verticale / Br.
PVD chocolate-vertical

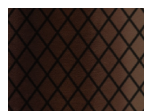

XP21G

Brushed PVD
chocolate-godronatura
diagonale / Br. PVD



XP31

Brushed PVD British gold /
Brushed PVD British gold



XP31G

Br. PVD British gold-godr.
verticale / Br. PVD British
gold-vertical knurling



XP31G

Br. PVD British gold-godr.
diagonale / Br. PVD British
gold-diagonal knurling



XP41

Brushed PVD gold / Brushed
PVD gold



XP41G

Br. PVD gold-godronatura
verticale / Brushed PVD
gold-vertical knurling



XP41G

Br. PVD gold-godr. diagonale /
Br. PVD gold-diagonal knurling



XP81

PVD Brushed Total Black /
PVD Brushed Total Black



XP81G

Br. PVD Total Black-godr.
verticale / Br. PVD Total
Black-vertical knurling



XP81G

Br. PVD Total Black-godr.
diagonale / Br. PVD Total
Black-diagonal knurling



XP91

Brushed PVD copper /
Brushed PVD copper

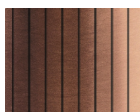

XP91G

Br. PVD copper-godr.
verticale / Br. PVD
copper-vertical knurling

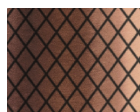

XP91G

Br. PVD copper-godr.
diagonale / Br. PVD
copper-diagonal knurling

Note / Notes

HELM

ZHL801.X

Disegno Complessivo / Overall Drawing

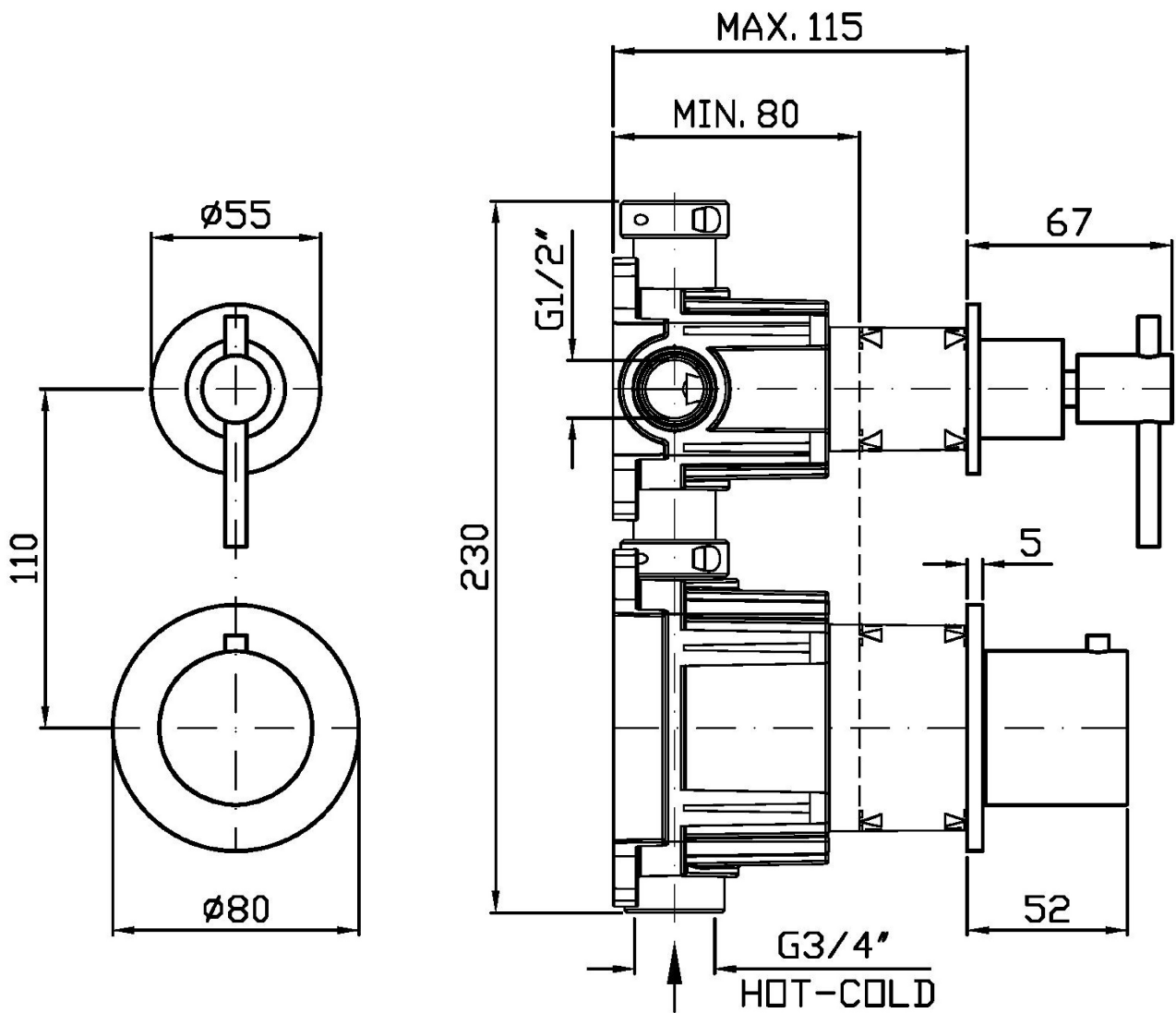

HELM

ZHL801.X

Esplosi / Exploded

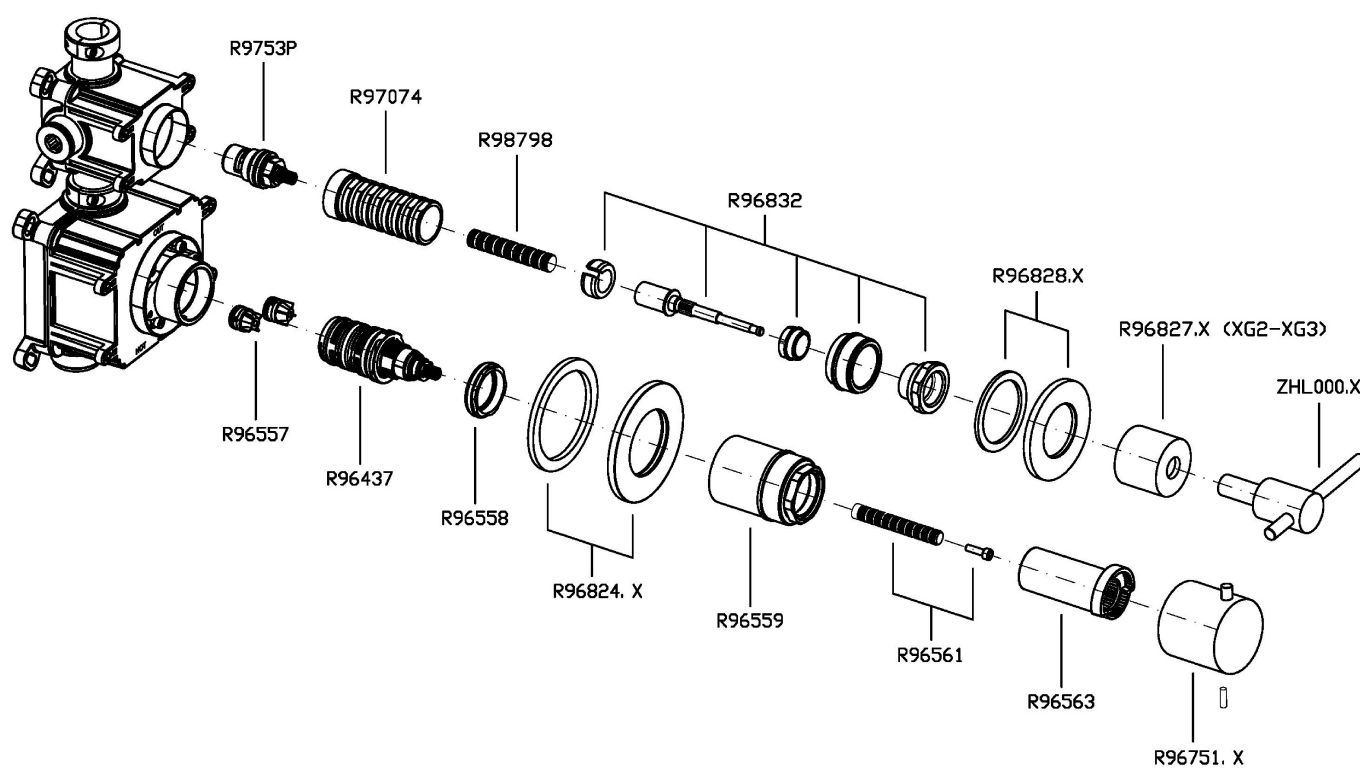

HELM

ZHL801.X

Portate / Flowrates (lt/min)

PRESSIONE PRESSURE	1 BAR	2 BAR	3 BAR	4 BAR	5 BAR
1 RUBINETTO APERTO <i>P1</i>	13,7	19,1	23,2	26,2	29,5
<i>P2</i>					
<i>P3</i>					
<i>P4</i>					
<i>P5</i>					

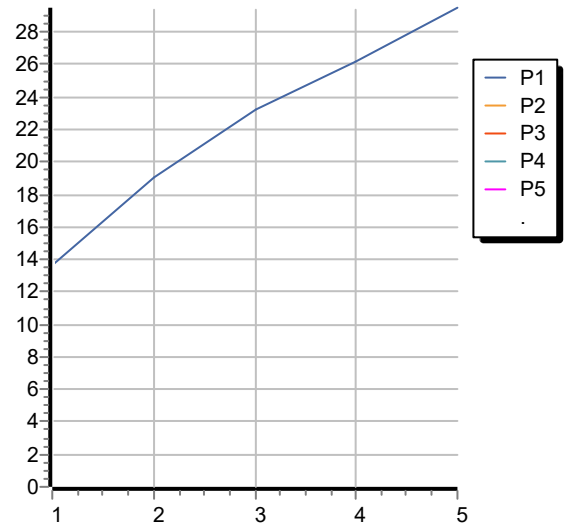

HELM

ZHL801.X

Pesi e Misure / Weights and Sizes

Peso (Kg) Weight (lb)	1,70 (Kg)	3,75 (lb)
Volume test (dc3) - (in3)	7,50 (dc3)	457,68 (in3)
h (mm) - (in)	90,00 (mm)	3,54 (in)
L1 (mm) - (in)	250,00 (mm)	9,84 (in)
L2 (mm) - (in)	330,00 (mm)	12,99 (in)

