

HELM

ZHL695.X

Gruppo incasso vasca-doccia. / 3 hole built-in bath-shower mixer.



Gruppo incasso vasca-doccia a 3 fori, in acciaio inox AISI 316L, con deviatore a 2 vie.



3 hole built-in bath-shower mixer in AISI 316L stainless steel, with 2 way diverter.

R99508

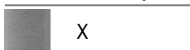
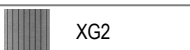
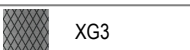
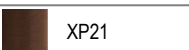
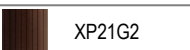
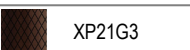
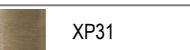
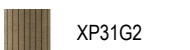
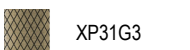

Parte incasso. / Built-in part.

Finiture / Finishes

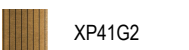
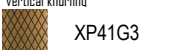
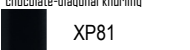
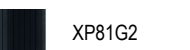
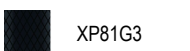
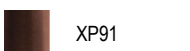
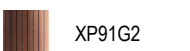
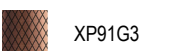
 X Acciaio inox spazzolato / Brushed stainless steel	 XG2 Acciaio inox spazz.-godr. verticale / Br. stainless steel-Vertical knurling	 XG3 Acciaio inox spazz.-godronatura diagonale / Br. stainless steel-diaagonal knurling	 XP21 Brushed PVD chocolate / Brushed PVD chocolate	 XP21G2 Brushed PVD chocolate godronatura verticale / Brushed PVD chocolate vertical knurling	 XP21G3 Brushed PVD chocolate-godronatura diagonale / Brushed PVD chocolate-diaagonal knurling	 XP31 Brushed PVD British gold / Brushed PVD British gold
 XP31G2 Br. PVD British gold-godr. verticale / Br. PVD British gold-vertical knurling	 XP31G3 Br. PVD British gold-godr. diagonale / Br. PVD British gold-diagonal knurling	 XP41 Brushed PVD gold / Brushed PVD gold	 XP41G2 Br. PVD gold-godronatura verticale / Brushed PVD gold-vertical knurling	 XP41G3 Br. PVD gold-godr. diagonale / Br. PVD gold-diagonal knurling	 XP81 PVD Brushed Total Black / PVD Brushed Total Black	 XP81G2 Br. PVD Total Black-godr. verticale / Br. PVD Total Black-vertical knurling
 XP81G3 Br. PVD Total Black-godr. diagonale / Br. PVD Total Black-diagonal knurling	 XP91 Brushed PVD copper / Brushed PVD copper	 XP91G2 Br. PVD copper-godr. verticale / Br. PVD copper-vertical knurling	 XP91G3 Br. PVD copper-godr. diagonale / Br. PVD copper-diagonal knurling			

HELM

ZHL695.X

Disegno Complessivo / Overall Drawing

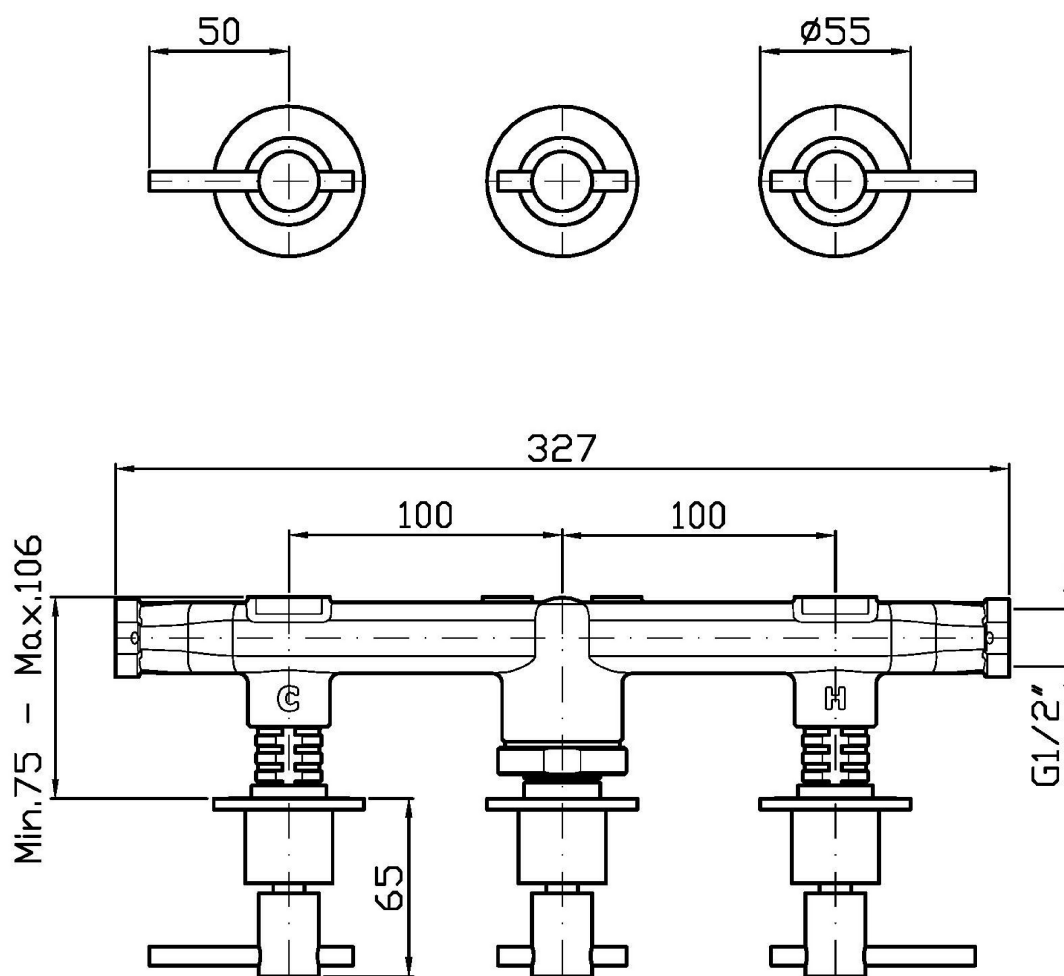

HELM

ZHL695.X

Esplosi / Exploded

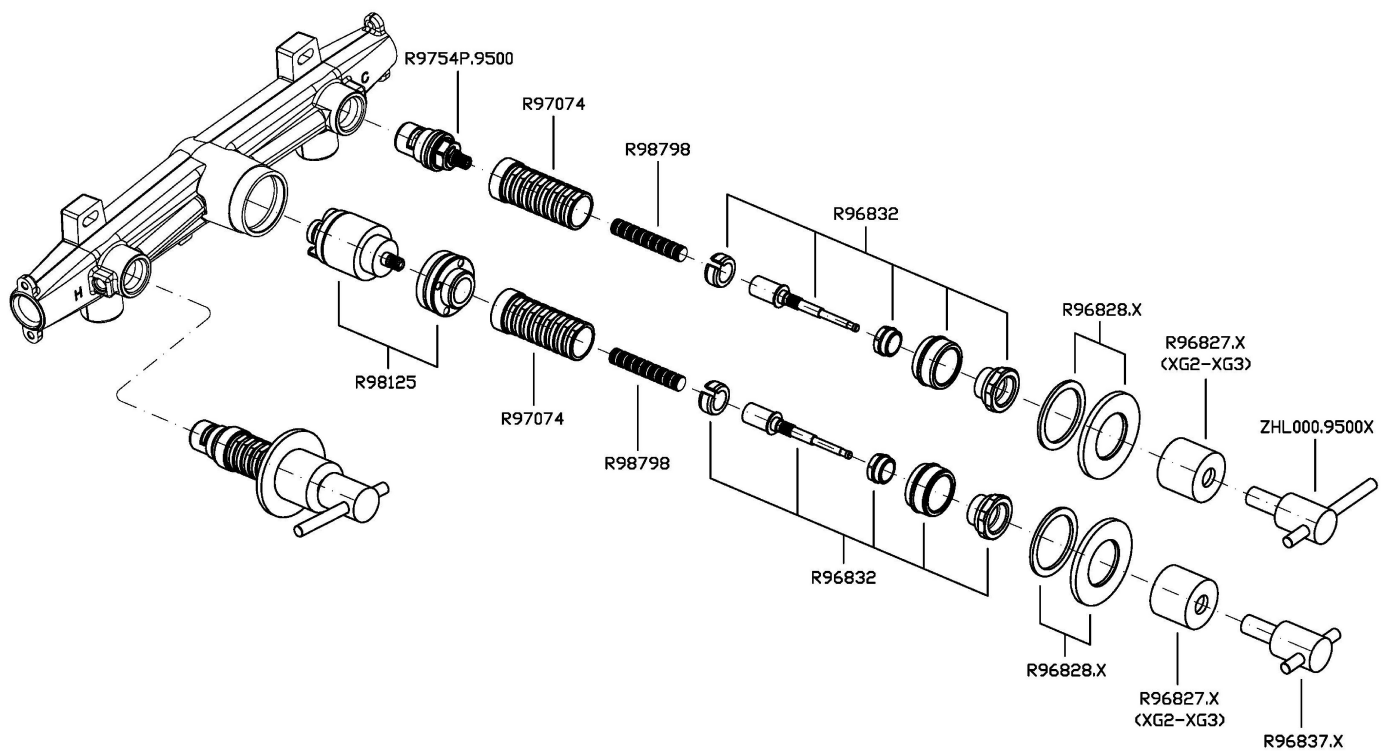

HELM

ZHL695.X

Portate / Flowrates (lt/min)

PRESSIONE PRESSURE	1 BAR	2 BAR	3 BAR	4 BAR	5 BAR
DEVIATORE <i>P1</i>	10,5	15,3	19	21,6	24
<i>P2</i>					
<i>P3</i>					
<i>P4</i>					
<i>P5</i>					

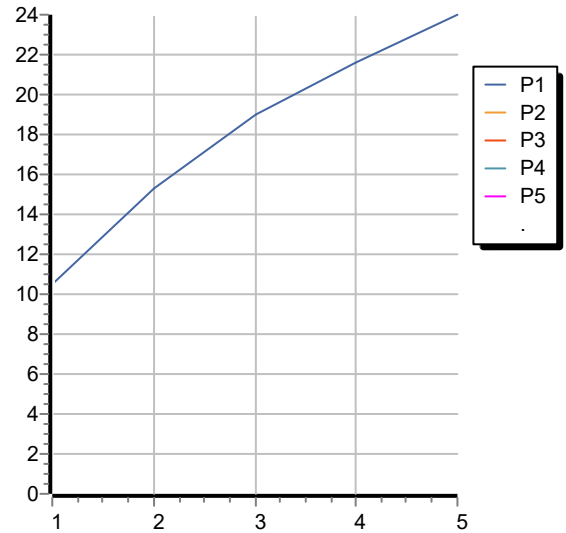

HELM

ZHL695.X

Pesi e Misure / Weights and Sizes

Peso (Kg) Weight (lb)	1,50 (Kg)	3,31 (lb)
Volume test (dc3) - (in3)	7,43 (dc3)	453,41 (in3)
h (mm) - (in)	90,00 (mm)	3,54 (in)
L1 (mm) - (in)	250,00 (mm)	9,84 (in)
L2 (mm) - (in)	333,00 (mm)	13,11 (in)

