

SHOWER

Z94272

Soffione Ø 300 mm a getto fisso. / Ø 300 mm shower head simple jet.



Soffione Ø 300 mm in acciaio inox cromato, a getto fisso, con sistema anticalcare. Spessore 4 mm.
Water Saving - portata d'acqua uguale o inferiore a 9 l/min.

Ø 300 mm chrome plated stainless steel shower head simple jet, with anti-limescale system. 4 mm thickness.
Water Saving - water flow rate of 9 l/min or less.

Finiture / Finishes



Cromo / Chrome

SHOWER

Z94272

Disegno Complessivo / Overall Drawing

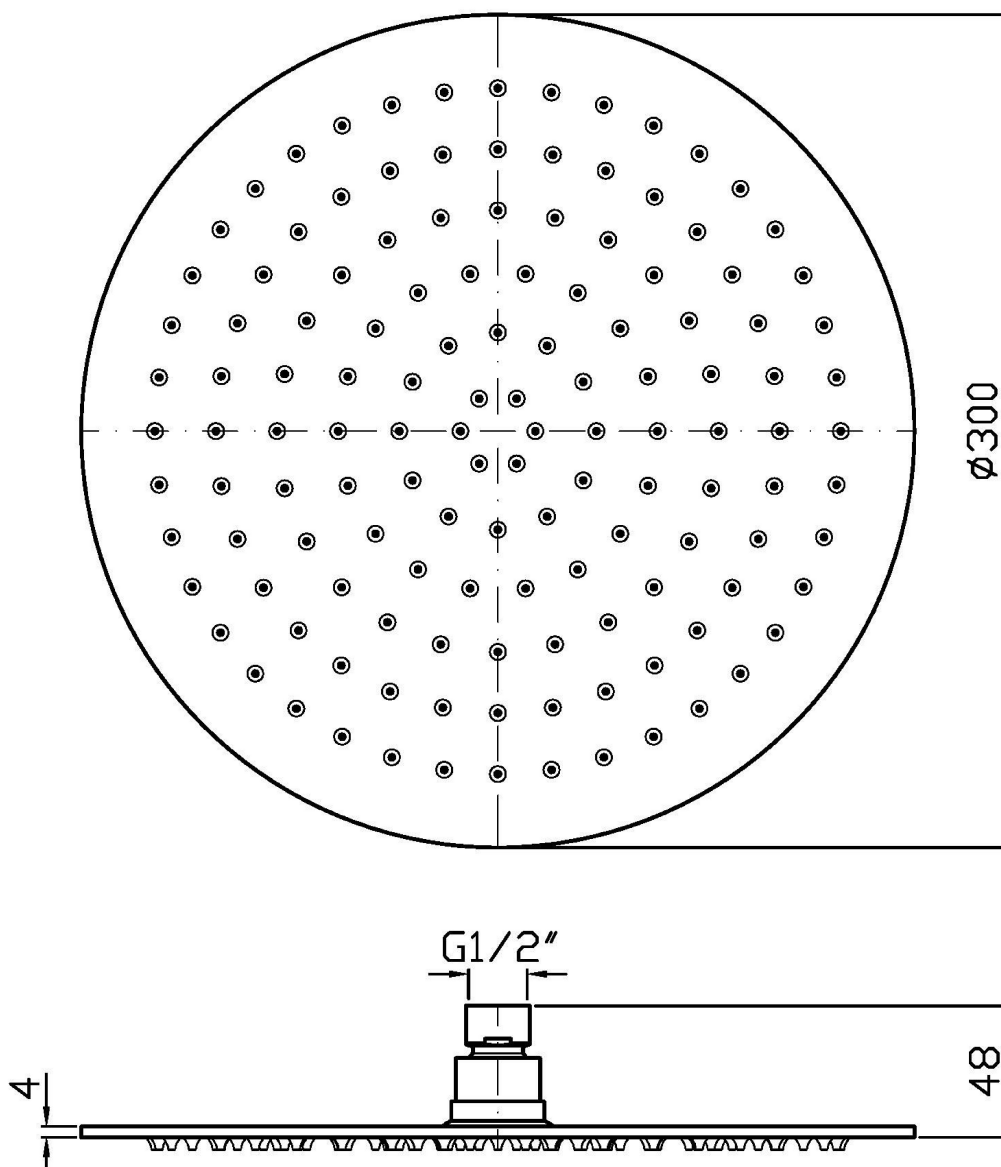

SHOWER

Z94272

Portate / Flowrates (lt/min)

PRESSIONE PRESSURE	1 BAR	2 BAR	3 BAR	4 BAR	5 BAR
P1 SOFFIONE SHOWER HEAD	8	9	9	9	9
P2					
P3					
P4					
P5					

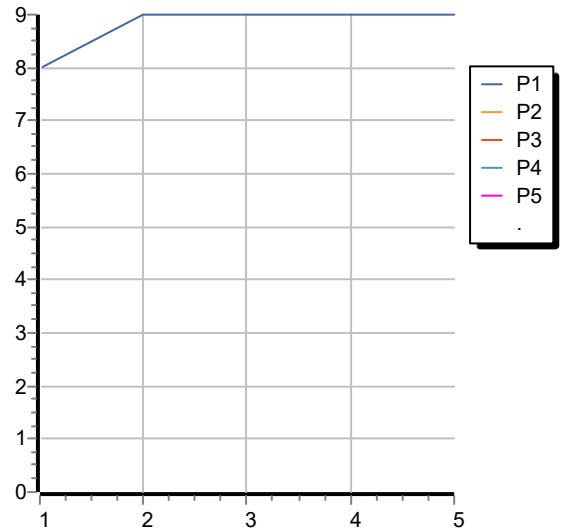

SHOWER

Z94272

Pesi e Misure / Weights and Sizes

Peso (Kg) Weight (lb)	2,30 (Kg)	5,07 (lb)
Volume test (dc3) - (in3)	7,14 (dc3)	435,71 (in3)
h (mm) - (in)	70,00 (mm)	2,76 (in)
L1 (mm) - (in)	315,00 (mm)	12,40 (in)
L2 (mm) - (in)	324,00 (mm)	12,76 (in)

