

SHOWER

Z94254.X

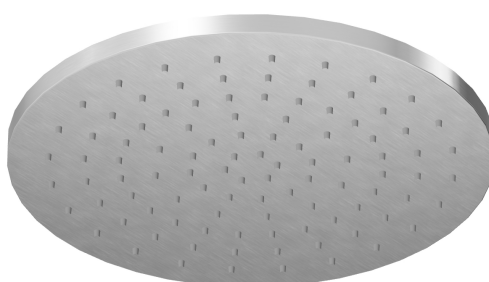





Soffione Ø 300 mm. / Ø 300 mm shower head.



Soffione Ø 300 mm in acciaio inox AISI 316L. A getto fisso con sistema anticalcare, spessore 14 mm. Ispezionabile. Water Saving - portata d'acqua uguale o inferiore a 9 l/min.

Ø 300 mm AISI 316L stainless steel shower head, with anti-limescale system. 14 mm thickness. Inspectionable. Water Saving - water flow rate of 9 l/min or less.

Finiture / Finishes

 X	 XP21	 XP31	 XP41	 XP81	 XP91
Acciaio inox spazzolato / Brushed stainless steel	Brushed PVD chocolate / Brushed PVD chocolate	Brushed PVD British gold / Brushed PVD British gold	Brushed PVD gold / Brushed PVD gold	PVD Brushed Total Black / PVD Brushed Total Black	Brushed PVD copper / Brushed PVD copper

SHOWER

Z94254.X

Disegno Complessivo / Overall Drawing

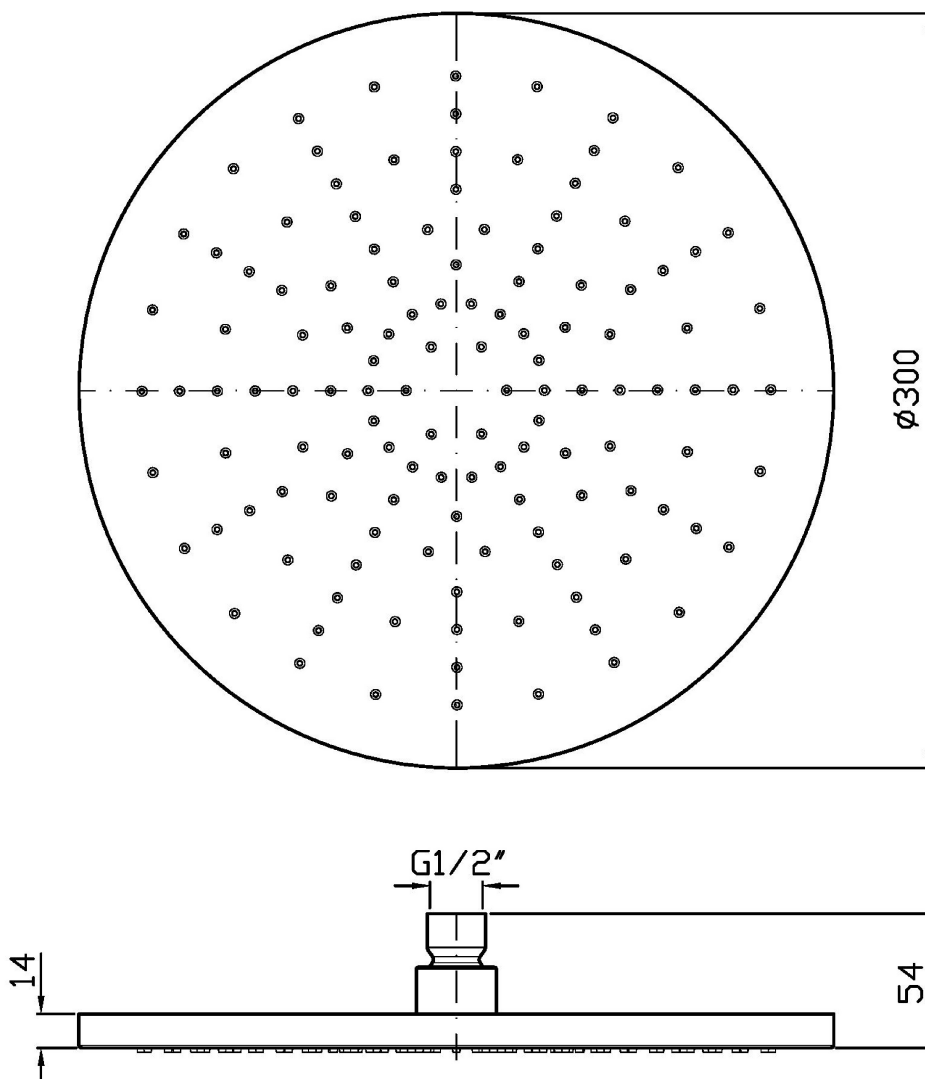

Note / Notes

SHOWER

Z94254.X

Portate / Flowrates (lt/min)

PRESSIONE PRESSURE	1 BAR	2 BAR	3 BAR	4 BAR	5 BAR
SOFFIONE SHOWER HEAD P1	7,9	8,4	8,6	8,8	9
P2					
P3					
P4					
P5					

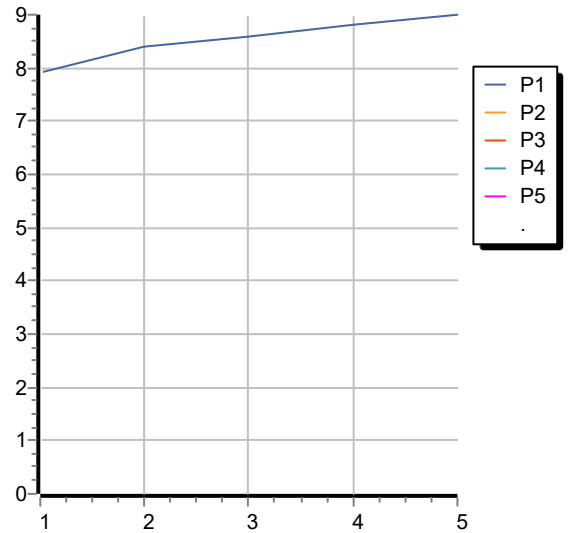

SHOWER

Z94254.X

Pesi e Misure / Weights and Sizes

Peso (Kg) Weight (lb)	0,00 (Kg)	0,00 (lb)
Volume test (dc3) - (in3)	0,00 (dc3)	0,00 (in3)
h (mm) - (in)	0,00 (mm)	0,00 (in)
L1 (mm) - (in)	0,00 (mm)	0,00 (in)
L2 (mm) - (in)	0,00 (mm)	0,00 (in)

