

SHOWER

Z93918.X

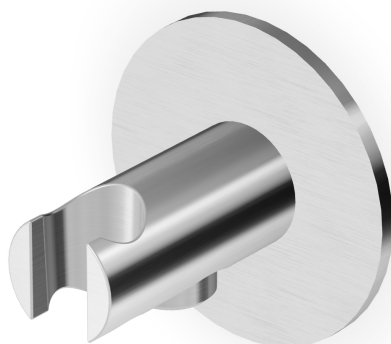











Appendidoccia duplex. / Shower support.



Appendidoccia duplex in acciaio inox, da 1/2"x1/2", per gruppo incasso.

Wall-mounted shower support in stainless steel, 1/2" x 1/2" hose connection.

Finiture / Finishes

 X Acciaio inox spazzolato / Brushed stainless steel	 XP21 Brushed PVD chocolate / Brushed PVD chocolate	 XP31 Brushed PVD British gold / Brushed PVD British gold	 XP41 Brushed PVD gold / Brushed PVD gold	 XP81 PVD Brushed Total Black / PVD Brushed Total Black	 XP91 Brushed PVD copper / Brushed PVD copper	 XS Acciaio inox matt / Matt stainless steel
 XSP21 Matt PVD chocolate / Matt PVD chocolate	 XSP31 Matt PVD British gold / Matt PVD British gold	 XSP41 Matt PVD gold / Matt PVD gold	 XSP81 Matt PVD total black / Matt PVD total black	 XSP91 Matt PVD copper / Matt PVD copper		

SHOWER

Z93918.X

Disegno Complessivo / Overall Drawing

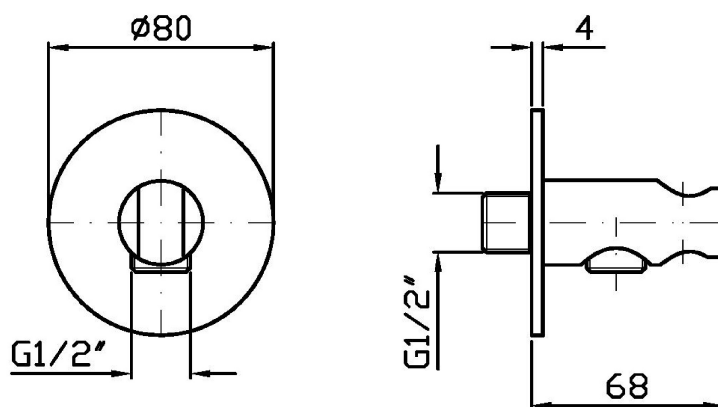

Note / Notes

SHOWER

Z93918.X

Portate / Flowrates (lt/min)

PRESSIONE PRESSURE	1 BAR	2 BAR	3 BAR	4 BAR	5 BAR
1 RUBINETTO APERTO <i>P1</i>	18,6	25,9	30,7	35,2	38,6
<i>P2</i>					
<i>P3</i>					
<i>P4</i>					
<i>P5</i>					

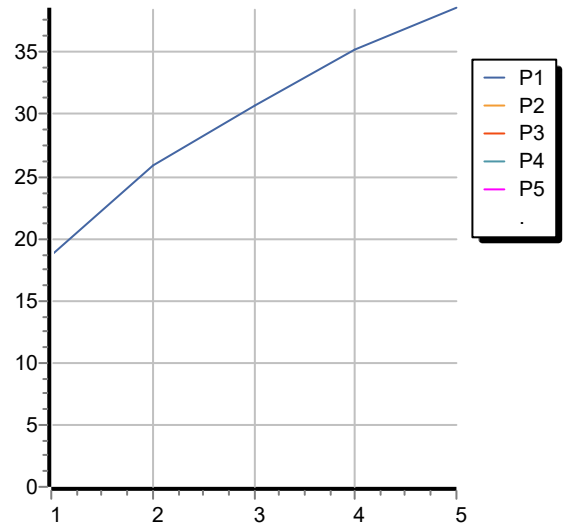

SHOWER

Z93918.X

Pesi e Misure / Weights and Sizes

Peso (Kg) Weight (lb)	0,28 (Kg)	0,62 (lb)
Volume test (dc3) - (in3)	1,21 (dc3)	73,84 (in3)
h (mm) - (in)	73,00 (mm)	2,87 (in)
L1 (mm) - (in)	127,00 (mm)	5,00 (in)
L2 (mm) - (in)	130,00 (mm)	5,12 (in)

