

SABLIER

Z92265.X













Bocca di erogazione. / Wall spout.



Bocca di erogazione in acciaio inox AISI 316L. Lunghezza 165 mm.

Wall spout in AISI 316L stainless steel. L. 165 mm.

Finiture / Finishes

 X Acciaio inox spazzolato / Brushed stainless steel	 XP21 Brushed PVD chocolate / Brushed PVD chocolate	 XP31 Brushed PVD British gold / Brushed PVD British gold	 XP41 Brushed PVD gold / Brushed PVD gold	 XP81 PVD Brushed Total Black / PVD Brushed Total Black	 XP91 Brushed PVD copper / Brushed PVD copper	 XS Acciaio inox matt / Matt stainless steel
 XSP21 Matt PVD chocolate / Matt PVD chocolate	 XSP31 Matt PVD British gold / Matt PVD British gold	 XSP41 Matt PVD gold / Matt PVD gold	 XSP81 Matt PVD total black / Matt PVD total black	 XSP91 Matt PVD copper / Matt PVD copper		

SABLIER

Z92265.X

Disegno Complessivo / Overall Drawing

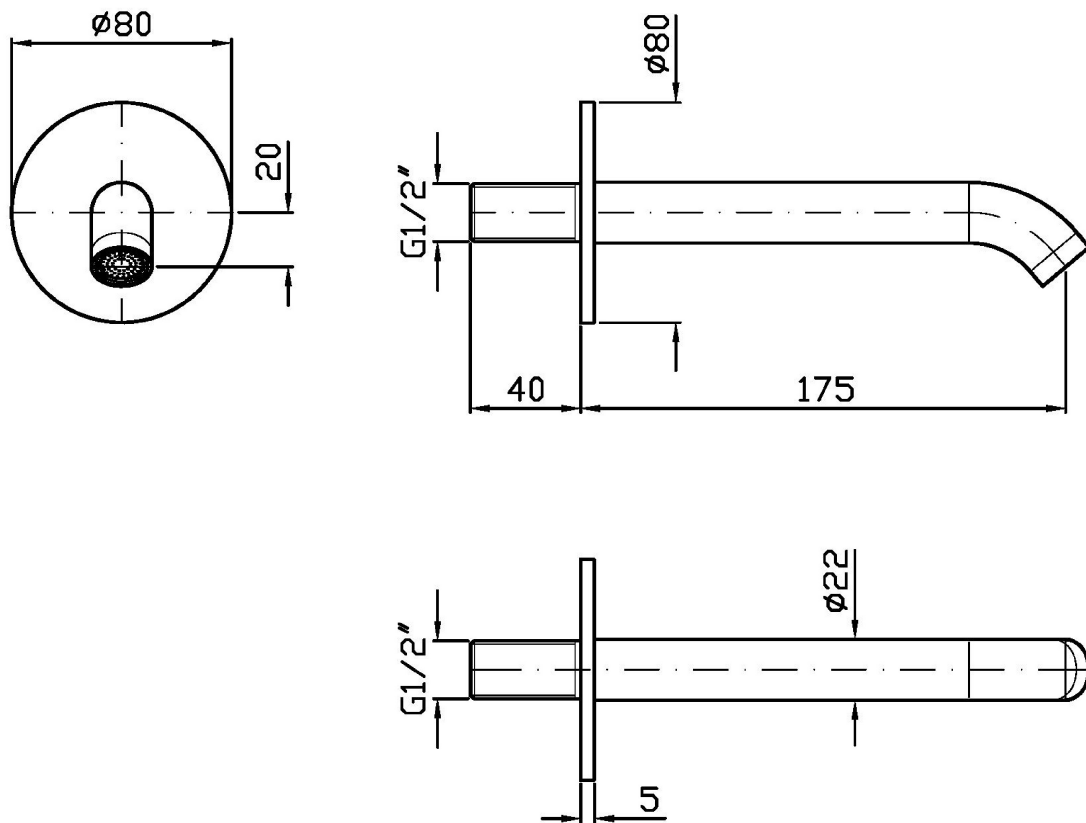

Note / Notes

SABLIER

Z92265.X

Portate / Flowrates (lt/min)

PRESSIONE PRESSURE	1 BAR	2 BAR	3 BAR	4 BAR	5 BAR
P1 BOCCA VASCA WALL SPOUT	11,5	16,5	20,3	23,5	26,4
P2					
P3					
P4					
P5					

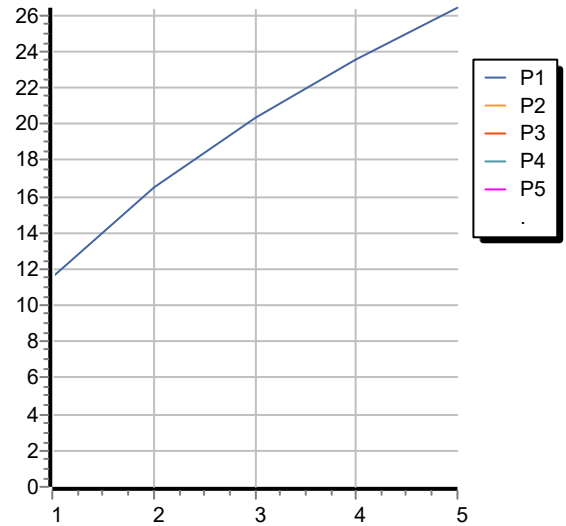

SABLIER

Z92265.X

Pesi e Misure / Weights and Sizes

Peso (Kg) Weight (lb)	0,55 (Kg)	1,21 (lb)
Volume test (dc3) - (in3)	1,15 (dc3)	70,18 (in3)
h (mm) - (in)	45,00 (mm)	1,77 (in)
L1 (mm) - (in)	134,00 (mm)	5,28 (in)
L2 (mm) - (in)	190,00 (mm)	7,48 (in)

