

## SABLIER

Z92264.X













Bocca di erogazione. / Wall spout.



Bocca di erogazione in acciaio inox AISI 316L. Lunghezza 195 mm.

Wall spout in AISI 316L stainless steel. L. 195 mm.

### Finiture / Finishes

 X Acciaio inox spazzolato / Brushed stainless steel	 XP21 Brushed PVD chocolate / Brushed PVD chocolate	 XP31 Brushed PVD British gold / Brushed PVD British gold	 XP41 Brushed PVD gold / Brushed PVD gold	 XP81 PVD Brushed Total Black / PVD Brushed Total Black	 XP91 Brushed PVD copper / Brushed PVD copper	 XS Acciaio inox matt / Matt stainless steel
 XSP21 Matt PVD chocolate / Matt PVD chocolate	 XSP31 Matt PVD British gold / Matt PVD British gold	 XSP41 Matt PVD gold / Matt PVD gold	 XSP81 Matt PVD total black / Matt PVD total black	 XSP91 Matt PVD copper / Matt PVD copper		

## SABLIER

Z92264.X

Disegno Complessivo / Overall Drawing

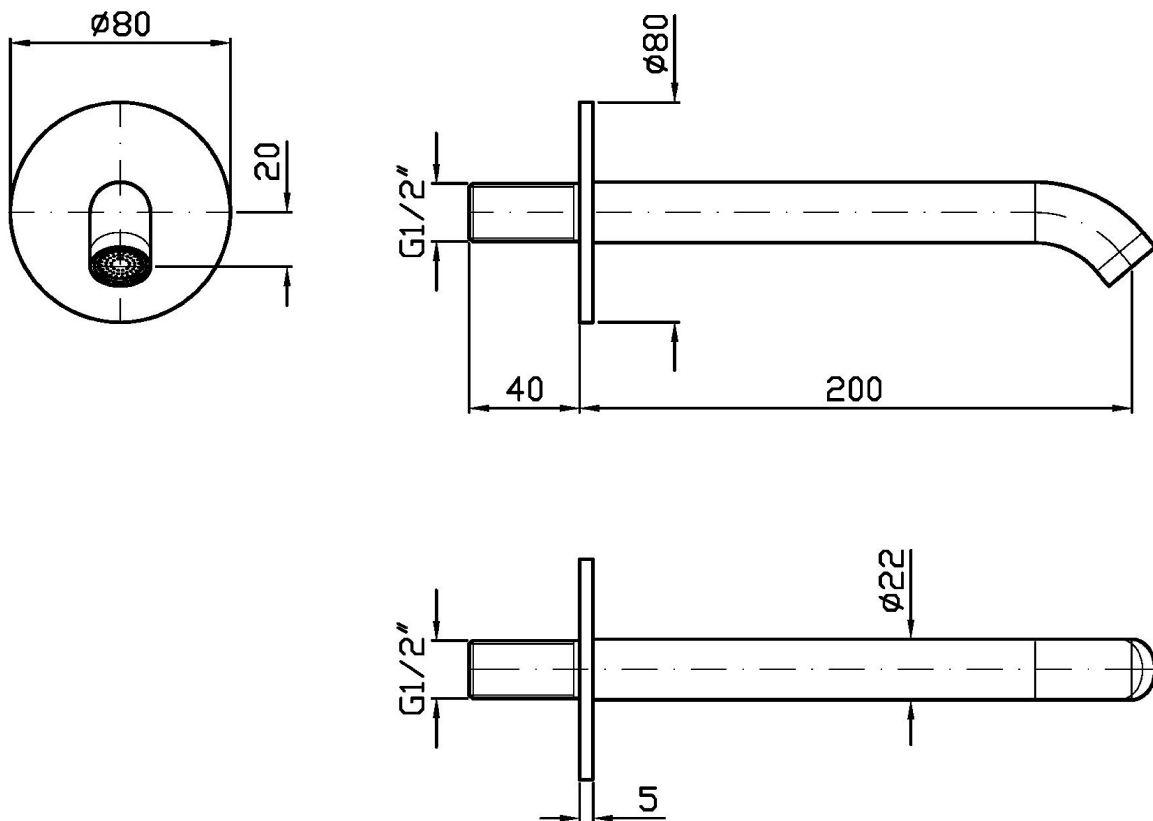

Note / Notes

## SABLIER

Z92264.X

Portate / Flowrates (lt/min)

PRESSIONE PRESSURE	1 BAR	2 BAR	3 BAR	4 BAR	5 BAR
P1 BOCCA VASCA WALL SPOUT	11,5	16,5	20,3	23,5	26,4
P2					
P3					
P4					
P5					

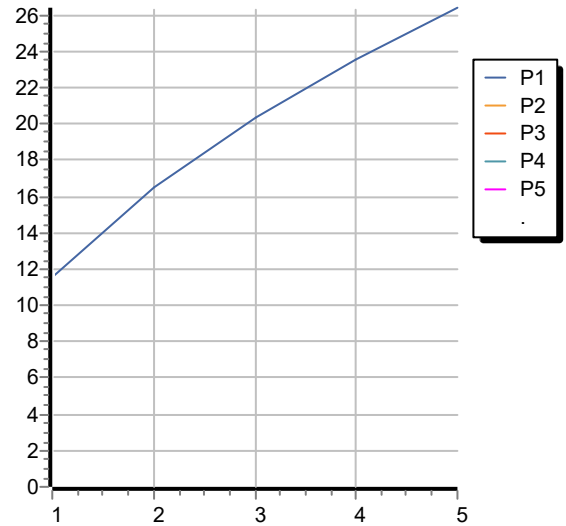

## SABLIER

Z92264.X

Pesi e Misure / Weights and Sizes

Peso ( Kg ) Weight ( lb )	0,60 ( Kg )	1,32 ( lb )
Volume test ( dc3 ) - ( in3 )	1,96 ( dc3 )	119,61 ( in3 )
h ( mm ) - ( in )	30,00 ( mm )	1,18 ( in )
L1 ( mm ) - ( in )	190,00 ( mm )	7,48 ( in )
L2 ( mm ) - ( in )	345,00 ( mm )	13,58 ( in )

