

MISCELLANEOUS

R97760

















Scarico universale. / Open waste.



Scarico universale. Uscita libera.

Open waste.

Finiture / Finishes

 C3 Cromo / Chrome	 C8 Nickel Spazzolato / Brushed Nickel	 C40 Nickel Lucido / Polished Nickel	 C41 Oro / Gold	 C50 Oro spazzolato / Brushed Gold	 C51 Metal Black / Metal Black	 C51 Metal Black spazzolato / Brushed Metal Black
 P70 PVD Oro Rosa / PVD Rose Gold	 W1 Bianco Opaco Goffrato / Embossed Matt White	 N1 Nero Opaco Goffrato / Embossed Matt Black	 N6 Nero opaco / Matt black	 L5 Blu mediterraneo / Mediterranean blu	 P21 PVD brushed chocolate / PVD brushed chocolate	 P31 Brushed PVD British gold / Brushed PVD British gold
 P41 PVD Oro Spazzolato / PVD Brushed Gold	 P81 Brushed total black PVD / Brushed total black PVD	 P91 Brushed PVD Copper / Brushed PVD Copper				

MISCELLANEOUS

R97760

Disegno Complessivo / Overall Drawing

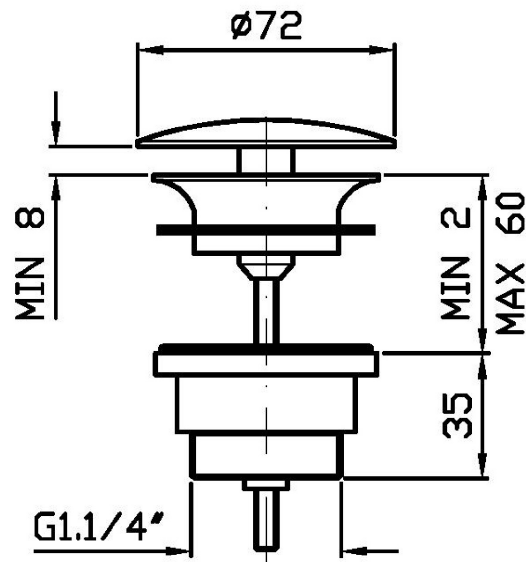

Note / Notes

MISCELLANEOUS

R97760

Pesi e Misure / Weights and Sizes

Peso (Kg) Weight (lb)	0,36 (Kg)	0,79 (lb)
Volume test (dc3) - (in3)	0,40 (dc3)	24,41 (in3)
h (mm) - (in)	94,00 (mm)	3,70 (in)
L1 (mm) - (in)	71,00 (mm)	2,80 (in)
L2 (mm) - (in)	71,00 (mm)	2,80 (in)

